

## Instruction Manual

pH/ORP/Conductivity Meter

LAQUAact-PC110

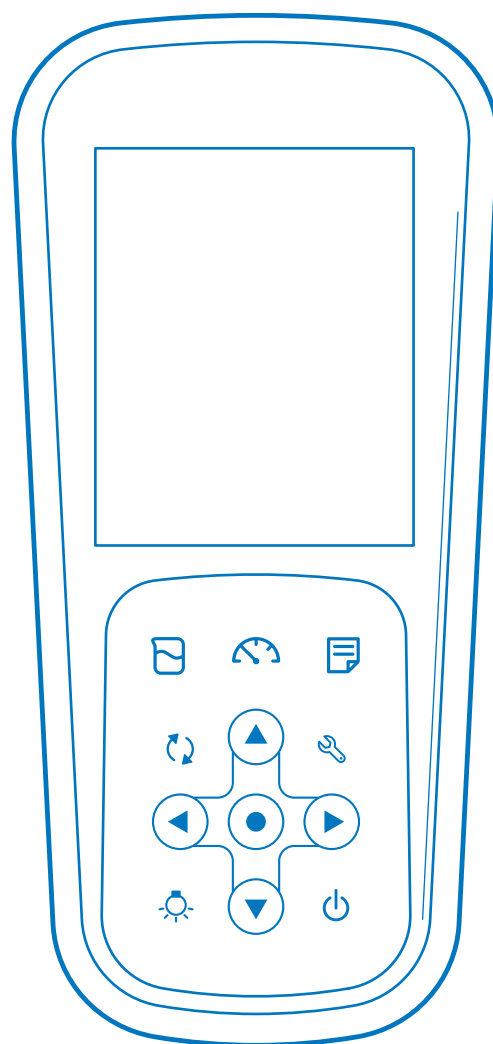



## ■ Preface

This manual describes the operation of the following instrument.

Brand (pet name): LAQUAact  
Series name: Portable pH · Water Quality Meter  
Model: LAQUAact-PC110  
Model description: pH/ORP/Conductivity Meter

Be sure to read this manual before using the product to ensure proper and safe operation of the product. Also safely store the manual so it is readily available whenever necessary.

Product specifications and appearance, as well as the contents of this manual are subject to change without notice.

## ● Warranty and responsibility

HORIBA Advanced Techno Co., Ltd. warrants that the Product shall be free from defects in material and workmanship and agrees to repair or replace free of charge, at option of HORIBA Advanced Techno Co., Ltd., any malfunctioned or damaged Product attributable to responsibility of HORIBA Advanced Techno Co., Ltd. for a period of Two (2) years from the delivery unless otherwise agreed with a written agreement. In any one of the following cases, none of the warranties set forth herein shall be extended;

- Any malfunction or damage attributable to improper operation
- Any malfunction attributable to repair or modification by any person not authorized by HORIBA Advanced Techno Co., Ltd.
- Any malfunction or damage attributable to the use in an environment not specified in this manual
- Any malfunction or damage attributable to violation of the instructions in this manual or operations in the manner not specified in this manual
- Any malfunction or damage attributable to any cause or causes beyond the reasonable control of HORIBA Advanced Techno Co., Ltd. such as natural disasters
- Any deterioration in appearance attributable to corrosion, rust, and so on
- Replacement of consumables

HORIBA Advanced Techno Co., Ltd. SHALL NOT BE LIABLE FOR ANY DAMAGES RESULTING FROM ANY MALFUNCTIONS OF THE PRODUCT, ANY ERASURE OF DATA, OR ANY OTHER USES OF THE PRODUCT.

## ● Trademarks

- Microsoft, Windows, Windows Vista are registered trademarks or trademarks of Microsoft Corporation in the United States and other countries.
- Other company names and brand names are either registered trademarks or trademarks of the respective companies. (R), (TM) symbols may be omitted in this manual.

CODE:GZ0000427799B

January, 2017 © 2017 HORIBA Advanced Techno Co., Ltd.

# Regulations

## ■ Regulations

### ● EU regulations

#### ● Conformable standards

This equipment conforms to the following standards:



<b>EMC:</b>	EN61326-1 Class B, Basic electromagnetic environment
<b>Safety:</b>	EN61010-1
<b>RoHS:</b>	EN50581 9. Monitoring and control instruments

**Warning:** This product is not intended for use in industrial environments. In an industrial environment, electromagnetic environmental effects may cause the incorrect performance of the product in which case the user may be required to take adequate measures.

#### ● Installation environment

This product is designed for the following environment.

- Overvoltage category II
- Pollution degree 2

#### ● Information on disposal of electrical and electronic equipment and disposal of batteries and accumulators

The crossed out wheeled bin symbol with underbar shown on the product or accompanying documents indicates the product requires appropriate treatment, collection and recycle for waste electrical and electronic equipment (WEEE) under the Directive 2012/19/EU, and/or waste batteries and accumulators under the Directive 2006/66/EC in the European Union.

The symbol might be put with one of the chemical symbols below. In this case, it satisfies the requirements of the Directive 2006/66/EC for the object chemical.

This product should not be disposed of as unsorted household waste.

Your correct disposal of WEEE, waste batteries and accumulators will contribute to reducing wasteful consumption of natural resources, and protecting human health and the environment from potential negative effects caused by hazardous substance in products.

Contact your supplier for information on applicable disposal methods.

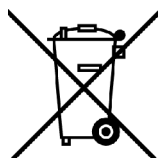

**Cd**



**Pb**



**Hg**

#### ● Authorised representative in EU

HORIBA UK Limited  
2 Dalston Gardens, Stanmore, Middx HA7 1BQ, UK

# Regulations

---

## ● FCC rules

Any changes or modifications not expressly approved by the party responsible for compliance shall void the user's authority to operate the equipment.

## ● Warning

This equipment has been tested and found to comply with the limits for a Class A digital device, pursuant to part 15 of the FCC Rules. These limits are designed to provide reasonable protection against harmful interference when the equipment is operated in a commercial environment. This equipment generates, uses, and can radiate radio frequency energy and, if not installed and used in accordance with the instruction manual, may cause harmful interference to radio communications.

Operation of this equipment in a residential area is likely to cause harmful interference in which case the user will be required to correct the interference at his own expense.

## ● Korea certification

### ● B급 기기 (가정용 방송통신기자재)

이 기기는 가정용(B 급) 전자파적합기기로서 주로 가정에서 사용하는 것을 목적으로 하며, 모든 지역에서 사용할 수 있습니다.

## ● Taiwan battery recycling mark



廢電池請回收

# Regulations

---

## ● China regulation

标记的意义

Meaning of Marking

マークの意味

本标记适用在中华人民共和国销售电器电子产品，标记中央的数字表示环境保护使用期限的年数。(不是表示产品质量保证期间。)只要遵守这个产品有关的安全和使用注意事项，从制造日开始算起在这个年限内，不会给环境污染、人体和财产带来严重的影响。请不要随意废弃本电器电子产品。

This marking is applied to electric and electronic products sold in the People's Republic of China. The figure at the center of the marking indicates the environmental protection use period in years. (It does not indicate a product guarantee period.) It guarantees that the product will not cause environment pollution nor serious influence on human body and property within the period of the indicated years which is counted from the date of manufacture as far as the safety and usage precautions for the product are observed. Do not throw away this product without any good reason.



本マークは、中華人民共和国で販売される電気電子製品に適用され、マークの中央の数字は環境保護使用期限の年数を意味します(製品の品質保証期間を示すものではありません)。この製品に関する安全や使用上の注意をお守り頂く限り、製造日から起算するこの年限内では、環境汚染や人体や財産に深刻な影響を及ぼすことはありません。本製品をみだりに廃棄しないでください。

# Regulations

## 产品中有害物质的名称及含量

### Name and amount of hazardous substance used in a product

部件名称 Unit name	有害物质 Hazardous substance					
	铅 Lead (Pb)	汞 Mer- cury (Hg)	镉 Cad- mium (Cd)	六价铬 Hexa- valent chrom- ium (Cr (VI))	多溴联苯 Poly bromo- biphenyl (PBB)	多溴二苯醚 Poly bromo- diphenyl ether (PBDE)
本体 Main unit	×	○	○	○	○	○
电池 Battery	×	○	○	○	○	○
AC适配器 AC adapter <sup>*1, *2</sup>	×	○	○	○	○	○
电缆 Cable <sup>*2</sup>	×	○	○	○	○	○
支架 Stand <sup>*2</sup>	○	○	○	○	○	○
打印机 Printer <sup>*2</sup>	×	○	○	○	○	○
电极 Electrode <sup>*2</sup>	×	○	×	○	○	○

本表格依据 SJ/T 11364 的规定编制。

This form is prepared in accordance with SJ/T 11364.

○：表示该有害物质在该部件所有均质材料中的含量均在 GB/T 26572 规定的限量要求以下。

Denotes that the amount of the hazardous substance contained in all of the homogeneous materials used in the component is below the limit on the acceptable amount stipulated in the GB/T 26572.

×：表示该有害物质至少在该部件的某一均质材料中的含量超出 GB/T 26572 规定的限量要求。

Denotes that the amount of the hazardous substance contained in any of the homogeneous materials used in the component is above the limit on the acceptable amount stipulated in the GB/T 26572.

\*1: 本部件的环保使用期限为10年。 The environmental protection use period of this product is 10 years.

\*2: 选配件 Optional products

# For Your Safety

---

## ■ For Your Safety

### ● Hazard classification and warning symbols

Warning messages are described in the following manner. Read the messages and follow the instructions carefully.

#### ● Hazard classification



This indicates an imminently hazardous situation which, if not avoided, will result in death or serious injury. This is to be limited to the most extreme situations.



This indicates a potentially hazardous situation which, if not avoided, could result in death or serious injury.



This indicates a potentially hazardous situation which, if not avoided, may result in minor or moderate injury. It may also be used to alert against unsafe practices.

#### ● Warning symbols



Description of what should be done, or what should be followed



Description of what should never be done, or what is prohibited

### ● [DEU] Sicherheitsinformation

Lesen Sie vor der Verwendung des Produkts unbedingt diese Anleitung, um den ordnungsgemäßen und sicheren Betrieb des Produkts zu gewährleisten. Bewahren Sie die Anleitung sicher auf, damit sie bei Bedarf jederzeit zur Hand ist.

Die Inhalt dieser Anleitung können ohne Vorankündigung geändert werden.

#### ● Installationsumgebung

Dieses Produkt ist nicht zum Gebrauch in industriellen Umgebungen, wie in EN61326-1 definiert, vorgesehen.

In einer industriellen Umgebung können die elektromagnetischen Störungen eventuell zu Produktfehlfunktionen führen. Um dieses Produkt unter solchen Umständen verwenden zu können, muss der Benutzer ggf. angemessene Maßnahmen ergreifen.

Das Produkt ist gemäß EN61010-1 für die folgende Umgebung vorgesehen.

- Überspannungskategorie II
- Verschmutzungsgrad 2



# For Your Safety

---

## ● [FRA] Informations de sécurité

Veillez à lire le présent manuel avant d'utiliser le produit de manière à garantir son utilisation correcte et sûre. De même, rangez le manuel dans un lieu sûr de manière à pouvoir vous y reporter lorsque cela est nécessaire.

Le contenu du présent manuel peut être modifié sans notification préalable.

## ● Environnement d'installation

Ce produit n'est pas destinés à une utilisation dans des environnements industriels, tels que définis dans la norme EN61326-1.

Dans un environnement industriel, les interférences électromagnétiques peuvent entraîner un dysfonctionnement du produit. Pour utiliser le produit dans ce type d'environnements, l'utilisateur peut avoir à prendre des mesures appropriées.

Le produit est conçu pour l'environnement suivant, tel que défini dans la norme EN61010-1.

- Catégorie de surtension II
- Degré de pollution 2

## ● [ITA] Informazioni sulla sicurezza

Leggere attentamente questo manuale prima di utilizzare il prodotto al fine di utilizzarlo in modo sicuro e adeguato. Inoltre, conservare in un luogo sicuro il manuale per poterlo consultare se necessario.

Le contenuti di questo manuale sono soggetti a modifiche senza preavviso.

## ● Ambiente di installazione

Questo prodotto non è stati progettati per essere utilizzati in ambienti industriali, secondo la norma EN61326-1.

In un ambiente industriale, le interferenze elettromagnetiche potrebbero causare un malfunzionamento del prodotto. Per utilizzare il prodotto in tali ambienti, all'utente potrebbe essere richiesto di adottare le contromisure necessarie.

Il prodotto è designato per il seguente ambiente, definito nello standard EN61010-1.

- Categoria di sovratensione II
- Livello di inquinamento 2

## ● [SWE] Säkerhetsinformation

Se till att du läser denna handbok innan du börjar använda produkten för en korrekt och säker användning av den. Spara sedan handboken på en säker och lättåtkomlig plats så att du kan konsultera den när så behövs.

Innehållet i denna handbok kan komma att ändras utan föregående meddelande därom.

## ● Installationsmiljö

Detta produkten är ej avsedda för användning i industriella miljöer enligt riktlinjerna i EN61326-1.

Om den används i industrimiljöer kan de elektromagnetiska störningarna orsaka tekniska fel hos produkten. Om produkten ska användas i sådana miljöer kan användaren behöva vidta lämpliga åtgärder för att lösa dessa problem.

Produkten är utformad för användning i följande miljöer, i enlighet med SS-EN 61010-1.

- Överspänningskategori II
- Föroreningsgrad 2

# For Your Safety

---

## ● [SPA] Información de seguridad

Asegúrese de leer este manual antes de utilizar el producto para garantizar un uso correcto y seguro del mismo. Asimismo, guarde de forma segura el manual para que esté disponible siempre que sea necesario.

El contenido de este manual están sujetos a cambios sin previo aviso.

## ● Entorno de instalación

Este producto está diseñado para su uso en entornos industriales, tal y como se define en EN61326-1.

En un entorno industrial, las interferencias electromagnéticas pueden provocar un funcionamiento incorrecto del producto. Para usar el producto en tales entornos, el usuario debe tomar las medidas adecuadas.

El producto se ha diseñado para el siguiente entorno, definido en EN61010-1.

- Categoría de sobretensión II
- Nivel de contaminación 2

## ● [POL] Informacje dotyczące bezpieczeństwa

Przed przystąpieniem do użytkowania tego produktu należy dokładnie zapoznać się z niniejszą instrukcją, aby zapewniona była prawidłowa i bezpieczna eksploatacja produktu. Instrukcję przechowywać w bezpiecznym miejscu, aby w razie potrzeby była zawsze dostępna.

Treść niniejszej instrukcji może ulec zmianie bez wcześniejszego powiadomienia.

## ● Środowisko instalacji

Ten produkt nie są przeznaczone do użytkowania w środowisku przemysłowym, zgodnie z definicją określoną w normie EN61326-1.

W środowisku przemysłowym zakłócenia elektromagnetyczne mogą powodować nieprawidłowe działanie produktów. Możliwe, że aby użytkować produkt w takich środowiskach, użytkownik będzie musiał podjąć stosowne środki zaradcze.

Produkt jest przeznaczony do użycia w poniższym środowisku zdefiniowanym w normie EN61010-1.

- Kategoria przepięciowa II
- Stopień zanieczyszczenia 2

# For Your Safety

---

## ● [NLD] Veiligheidsinformatie

Lees deze handleiding voordat u dit product gebruikt zodat u het op de juiste manier en veilig kunt gebruiken. Bewaar de handleiding goed zodat u hem wanneer nodig kunt raadplegen.

De inhoud van deze handleiding kunnen zonder voorafgaande kennisgeving worden gewijzigd.

## ● Installatieomgeving

Dit product is niet bedoeld voor gebruik in een industriële omgeving zoals gedefinieerd in EN 61326-1.

In een industriële omgeving kan de elektromagnetische interferentie de werking van dit product storen. Voor gebruik van het product in een dergelijke omgeving moet de gebruiker mogelijk maatregelen treffen om de storing te verhelpen.

Het product is ontworpen voor de volgende omgeving, gedefinieerd in EN 61010-1.

- Overspanningscategorie II
- Vervuilingsgraad 2

## ● [JPN] 安全情報

ご使用になる前に、本書を必ずお読みください。お読みになった後は必要なときにすぐに取り出せるように大切に保管してください。

本書に記載されている内容は予告なく変更される場合があります。あらかじめご了承ください。

## ● 設置環境

本製品は、EN61326-1 で定義される工業環境で使用することを想定した製品ではありません。

工業環境においては、電磁妨害の影響を受ける可能性があり、その場合には使用者が適切な対策を講ずることが必要となることがあります。

本製品は、EN61010-1 で定義される以下の環境用に設計されています。

- 過電圧カテゴリー II
- 汚染度 2



# For Your Safety





---

## ● Safety precautions

This section provides precautions for using the product safely and correctly and to prevent injury and damage. The terms of DANGER, WARNING, and CAUTION indicate the degree of imminency and hazardous situation. Read the precautions carefully as it contains important safety messages.

## ● Instrument and electrode





 <b>WARNING</b>	
	Do not use an unspecified AC adapter. Otherwise, it may heat up or be ignited resulting in a fire or an accident.
	Do not disassemble or modify the instrument. Otherwise, it may heat up or be ignited resulting in a fire or an accident.



 <b>CAUTION</b>	
	<b>Harmful chemicals</b> The internal solution of a pH electrode is highly concentrated potassium chloride (3.33 mol/L KCl). If the internal solution comes in contact with the skin, wash it off immediately. If it gets into the eyes, flush with plenty of water and then consult a doctor.
	<b>Broken glass</b> Broken glass may cause injury. The outer tube and tip of an electrode are made of glass. Handle them with care.
	Do not use the RS-232C communication and the AC adapter under wet or humid conditions. Otherwise, it may cause a fire, electric shock, or breakage.

# For Your Safety

---

## ● Battery

 CAUTION	
	Keep batteries out of reach of children. If someone accidentally swallows a battery, consult a doctor immediately.
	If alkaline fluid from a battery gets into the eyes, do not rub the eyes, rinse with clean water immediately and then consult a doctor. Contact with alkaline fluid could cause blindness.
	Do not put batteries in a fire, expose to heat, disassemble or remodel. Doing so could cause fluid leakage, overheating or explosion.

 CAUTION	
	Do not remove or scratch the external label of the battery. Doing so could cause injury to hands and fingers.

# Product Handling Information

---

## ■ Product Handling Information

### ● Operational precautions (instrument)

- Only use the product including accessories for their intended purpose.
- Do not drop, crash, or give any physical impact on the instrument.
- The instrument is made of solvent-resistant materials but that does not mean it is resistant to all chemicals. Do not dip the instrument in strong acid or alkali solution, or wipe with such solution.
- If the instrument is dropped into water or gets wet, wipe it using soft cloth. Do not heat to dry it with a hair-dryer (or the like).
- The instrument has a dust-proof and waterproof structure. Waterproof performance is following specification: the instrument does not malfunction even when immersed in water of 1 m depth for 30 minutes.  
This does not mean to guarantee non-destructive, trouble-free, dust-proof, and waterproof performance in all situations. If the instrument is correctly handled according to the descriptions in this manual, the instrument provides dust-proof and waterproof performance.
- When replacing the batteries with an AC adapter or a serial cable connected the instrument does not have the dust-proof and waterproof performance. The dust-proof and waterproof performance is maintained only when the covers are attached correctly.
- After replacing the batteries with an AC adapter or a serial cable connected make sure that the waterproof packing attached to each cover is not deformed or discolored, or has foreign matter adhering to it. If the waterproof packing is deformed, discolored or has foreign matter adhering to it, or dust could get inside, water leaks could occur that could lead to instrument malfunction.
- To disconnect an electrode, AC adapter cable or serial cable, hold the connector and pull it off. If you pull at the cable, it may cause a breakage.
- The RS-232C communication between the instrument and a personal computer (referred to as PC in the rest of this document) may fail because of environmental conditions, such as (radio/electromagnetic) noise.
- Do not replace the batteries in a dusty place or with wet hands while an AC adapter or a serial cable is connected. Dust or moisture could get inside the instrument, possibly causing instrument malfunction.
- Do not use the tip of a nail or an object with a sharp end to press the keys.
- If the power supply is interrupted while measurement data is being saved in the instrument, the data could be corrupted.

# Product Handling Information

---

- A Ni–MH rechargeable battery can be used in this instrument, but the battery used in the instrument cannot be charged using the AC adapter.

## ● Operational precautions (battery)

- Do not short-circuit a battery.
- Set the + and – side of the battery correctly.
- When the battery has run out or the instrument will not be used for a long time, remove the batteries.
- Of the specified battery types, make sure to use two batteries of the same type.
- Do not use a new battery together with a used battery.
- Do not use a fully charged nickel-metal hydride battery together with a partially charged battery.
- Do not attempt to charge a non-rechargeable battery.

## ● Environmental conditions for use and storage

- Temperature: 0°C to 45°C
- Humidity: under 80% in relative humidity and free from condensation

### **Avoid the following conditions.**

- Strong vibration
- Direct sunlight
- Corrosive gas environment
- Close to an air-conditioner
- Direct wind

## ● Transportation

When transporting the instrument, repackage it in the original package box. Otherwise, it may cause instrument breakage.

## ● Disposal

- Standard solution used for the calibration must be under neutralized before the disposal.
- When disposing of the product, follow the related laws and/or regulations of your country for disposal of the product.

# Manual Information

---

## ■ Manual Information

### ● Description in this manual

---

**Note**

---

This interprets the necessary points for correct operation and notifies the important points for handling the product.

---

---

**Reference**

---

This indicates the part where to refer for information.

---

---

**Tip**

---

This indicates reference information.

---



# Contents

■ Preface.....	I
■ Regulations .....	II
■ For Your Safety .....	VI
■ Product Handling Information.....	XII
■ Manual Information .....	XIV
<b>Part Names and Basic Operation .....</b>	<b>1</b>
■ Names of each part .....	2
● Instrument.....	2
● Identification of manufacturing date .....	3
● Display .....	4
● Operation key .....	6
■ Basic operation.....	7
● Function layer.....	7
● Changing the operation mode .....	11
● Switching the displays .....	12
● Changing the measurement parameter .....	13
● Using the backlight.....	14
● Entering numeric values .....	15
● Saving measurement data in the internal memory .....	16
<b>Measurement .....</b>	<b>17</b>
■ Preparation.....	18
● Confirmation before starting measurement .....	18
● Turning ON the instrument .....	19
● Connecting an electrode .....	22
■ pH measurement .....	23
● Setting the instrument.....	23
● Performing calibration.....	27

# Contents

● Performing measurement .....	35
● Saving measured value .....	36
■ mV, ORP measurement .....	37
● Switching between absolute value and relative value .....	37
● Performing measurement .....	38
● Saving measured value .....	39
■ Conductivity measurement.....	40
● Setting the instrument.....	41
● Performing conductivity calibration .....	57
● Performing measurement .....	61
● Saving measured values .....	62
<b>Using Various Functions.....</b>	<b>63</b>
■ Data functions .....	64
● Displaying saved data .....	64
● Using the automatic data save .....	65
● Deleting all saved data .....	68
■ Measurement setting.....	70
● Displaying the latest calibration and inspection data.....	70
● Changing the calibration method.....	73
● Using the calibration interval alarm (default: OFF) .....	74
● Deleting calibration data .....	75
■ Temperature settings .....	77
● Calibrating temperature sensor .....	77
■ General settings.....	79
● Setting the auto stability and auto hold function .....	79
● Changing the automatic power off setting (default: 30 min) .....	81
● Resetting to factory default settings .....	83
● Setting the date and time .....	85

# Contents

● Performing test printing of the printer unit .....	87
■ Other settings .....	89
● Printing measured values and calibration data .....	89
● Transferring saved data to a PC .....	93
● Operating the instrument from an external device .....	94
<b>Maintenance .....</b>	<b>95</b>
● Contact for maintenance .....	95
● Maintenance and storage of the instrument.....	95
● Environmental conditions for storage .....	95
● Maintenance and storage of the pH electrode .....	96
● Maintenance and storage of the ORP electrode .....	97
● Checking the state of the ORP electrode.....	98
● Maintenance and storage of the conductivity cell.....	99
<b>How to Resolve Errors or Troubles .....</b>	<b>101</b>
■ When an error message appears .....	101
● ERR No.0001 Memory error .....	101
● ERR No.0002 Empty battery level .....	102
● ERR No.0004 Asymmetric potential error .....	102
● ERR No.0005 Electrode sensitivity error.....	103
● ERR No.0006 Maximum calibration points exceeded .....	103
● ERR No.0007 Cannot identify standard solution.....	103
● ERR No.0008 Calibration interval error .....	104
● ERR No.0009 Printer error .....	104
● ERR No.0010 Memory full.....	104
● ERR No.0011 Cell constant is out of range.....	104
■ Troubleshooting .....	105
● The indicated value fluctuates.....	105
● The response is slow.....	106

# Contents

● The indicated value does not change/No response .....	106
● The measured value is out of the measurement range.....	107
● Repeatability of the measured value is poor .....	107
● Nothing appears when the power is turned ON.....	108
● Swelling of operation key sheet .....	108
● Part of the display is missing .....	108
<b>Appendix.....</b>	<b>109</b>
■ <b>Main specifications.....</b>	<b>109</b>
● Table of conductivity cell range .....	111
● Table of conductivity cell range (resistivity range) .....	112
■ <b>Instrument default settings.....</b>	<b>113</b>
■ <b>Technical note.....</b>	<b>114</b>
● pH standard solutions at various temperatures .....	114
● Conductivity standard values at various temperatures.....	115
■ <b>Options .....</b>	<b>116</b>

# Part Names and Basic Operation

This section describes the name of each part and the main role, function, and basic operation method of each part.

■ Names of each part.....	2
● Instrument.....	2
● Identification of manufacturing date .....	3
● Display.....	4
● Operation key .....	6
■ Basic operation .....	7
● Function layer.....	7
● Changing the operation mode .....	11
● Switching the displays.....	12
● Changing the measurement parameter.....	13
● Using the backlight .....	14
● Entering numeric values.....	15
● Saving measurement data in the internal memory .....	16

## ■ Names of each part

### ● Instrument

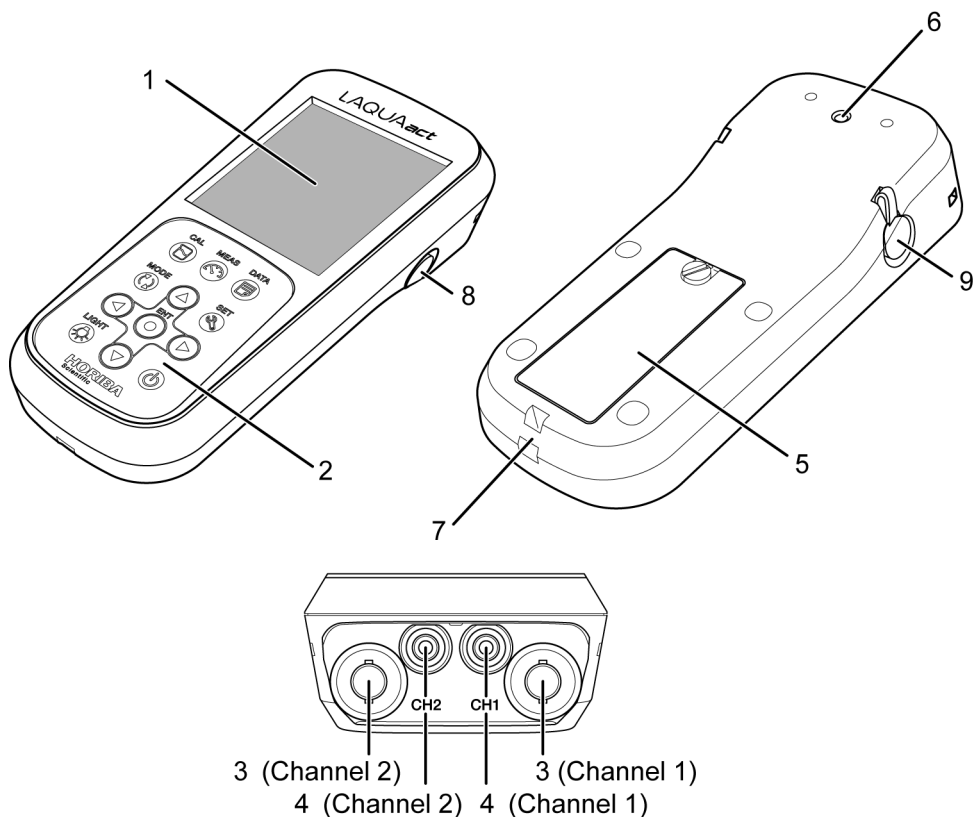

No.	Name	Function
1	Display	Displays the measured value and set value and so on.
2	Operation keys	Used for instrument operation.
3	Electrode connector	Connects the BNC connector of the electrode.
4	Temperature connector (T)	Connects the temperature connector (T) of the electrode.
5	Battery cover	Set batteries inside.
6	Electrode hook attachment section	Attach the electrode hook to carry with instrument.
7	Strap attachment section	Attach a strap.
8	Serial connector	Connects the serial cable and printer cable.
9	AC adapter jack	Connects an optional AC adapter.

## ● Identification of manufacturing date

Manufacturing date can be identified from MFG No. described in the ID label on the backside of the instrument.

Third number from the left in the MFG No. indicates manufacturing year.

Fourth alphabet from the left in the MFG No. indicates manufacturing month.

The alphabet is assigned to month according to the table below.

Ex.: ID: AA6A0000 means the device manufactured in 2016 January.

JAN	FEB	MAR	APR	MAY	JUN	JUL	AUG	SEP	OCT	NOV	DEC
A	B	C	D	E	F	G	H	J	K	L	M

## ● Display

Two electrodes can be connected to measure two parameters at the same time with this instrument. The display is divided into the main screen and the sub screen, and you can select the channel displayed on the main screen. The selected channel can be identified with an icon.

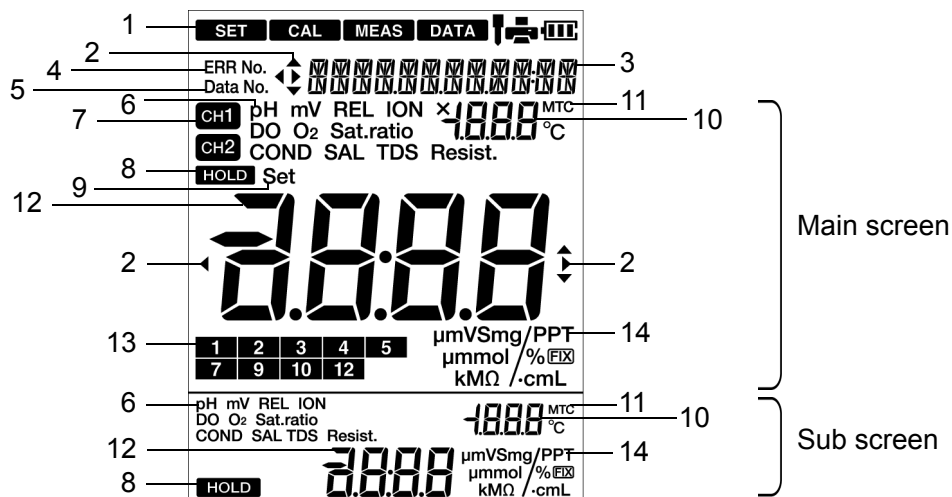

No.	Name	Function
1	Status icon	Displays the current operation mode, electrode status, printer or PC connection status, and remaining battery level.
2	Direction key icon	Displays the currently available direction key.
3	Date and time, set item display area	Displays the current date and time and the set items.
4	ERR No. icon	Displays an error No.
5	Data No. icon	Displays the data No.
6	Measurement parameter display area	Displays the currently set measurement parameter. This is displayed in the main screen and the sub screen, respectively.
7	Main screen channel icon	Displays the channel of the main screen.
8	HOLD icon	Lights when the measured value display is fixed in auto hold mode. This is displayed in the main screen and the sub screen, respectively.
9	SET icon	Lights when numerical values are entered.
10	Temperature display area	Displays the measured and the set temperature. This is displayed in the main screen and the sub screen, respectively.
11	MTC icon	Lights when the temperature setting is MTC (optional temperature setting). This is displayed in the main screen and the sub screen, respectively.



No.	Name	Function
12	Measured value, set item display area	Displays the measured value and the set value. This is displayed in the main screen and the sub screen, respectively.
13	Standard solution calibration history icon	When calibrating pH or conductivity standard solution, the corresponding icon lights.
14	Unit display area	Displays the unit for the measurement parameter and the display item. This is displayed in the main screen and the sub screen, respectively.

### •Battery level display



Battery level is high.



Battery level is a little lower.



Battery level is low.  
The backlight may become unavailable.



Battery has run out. Replace the batteries or use AC adapter (option).  
"ERR No. 0002" is displayed and operation is disabled.

## ● Operation key

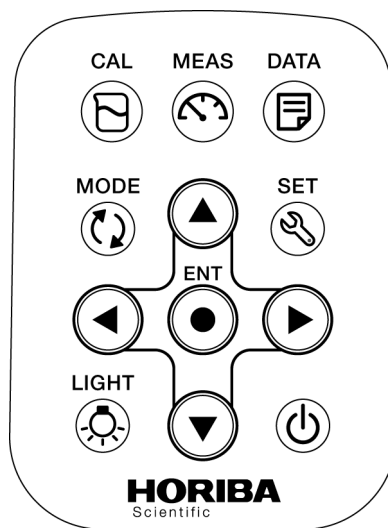

Key	Name	Function
	MEAS key	Changes the operation mode to the measurement mode during operation in a different mode. Releases the fixed measurement value mode in the auto hold mode.
	CAL key	Changes from the measurement mode to the calibration mode. Start calibration in the calibration mode.
	DATA key	Changes from the measurement mode to the data mode.
	SET key	Changes from the measurement mode to the setting mode. Starts repeatability inspection after calibration is complete.
	POWER key	Turns ON/OFF the power of instrument.
	MODE key	In the measurement mode, changes measurement parameters.
	LIGHT key	Turns on/off the backlight.
	ENTER key	Determines the selection or setting. Prints data in measurement, the calibration and data mode.
	UP key	In the measurement mode, switches the display between the main screen and the sub screen. Changes the selected item.
	DOWN key	Changes the number of the selected digit when entering numbers.
	LEFT key	Changes the selected item.
	RIGHT key	Changes the selected digit when entering numbers.



## ■ Basic operation

### ● Function layer

The function layer of the data mode and setting mode is shown as below.

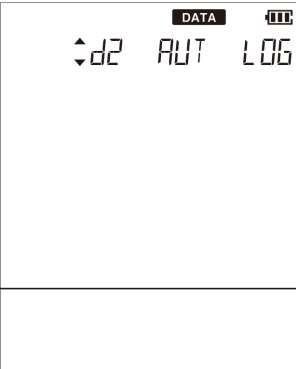

"dX" and "PXX" indicates the program number which is shown in the screen of the instrument.

#### • Data mode

Screen	Layer	Description
 <p>The screenshot shows a digital display with 'DATA' at the top right and a battery icon. The main display area shows 'd1 DATA OUT' with a double-headed arrow next to 'd1'. There is a horizontal line below the main display area.</p>	d1: DATA OUT	Saved data display
 <p>The screenshot shows a digital display with 'DATA' at the top right and a battery icon. The main display area shows 'd2 AUT LOG' with a double-headed arrow next to 'd2'. There is a horizontal line below the main display area.</p>	d2: AUT LOG	Automatic data save setting
 <p>The screenshot shows a digital display with 'DATA' at the top right and a battery icon. The main display area shows 'd3 DATA CLR' with a double-headed arrow next to 'd3'. There is a horizontal line below the main display area.</p>	d3: DATA CLR	Deletion of saved data

• **Setting mode**

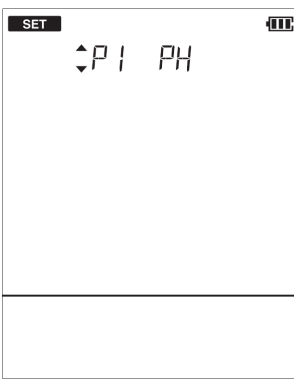
<Channel 1>

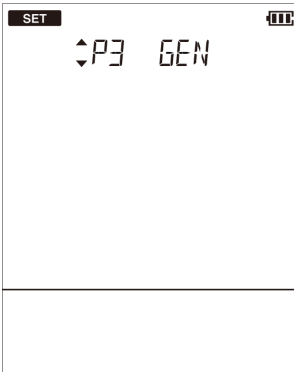
Screen	Layer	Description
 <p>Screen P1: PH. The screen shows 'SET' in the top left, 'P1 PH' in the center, and a battery icon in the top right.</p>	P1: PH	pH measurement settings
	P11: BUF	Selection of standard solution type for calibration: USA, NIST, CUST
	P12: CAL DATA	Calibration data display
	P13: CAL ALR	Calibration alarm setting: 1 day to 400 days
	P14: CAL CLR	Deletion of calibration data
 <p>Screen P2: TEMP. The screen shows 'SET' in the top left, 'P2 TEMP' in the center, and a battery icon in the top right.</p>	P2: TEMP	Temperature setting
		Selection of temperature conversion or display : ATC, MTC
 <p>Screen P3: GEN. The screen shows 'SET' in the top left, 'P3 GEN' in the center, and a battery icon in the top right.</p>	P3: GEN	General settings
	P31: MEAS	Selection of auto hold type: auto stability, auto hold
	P32: AUTO OFF	Automatic power off setting: 0 min to 30 min
	P33: RESET	Initialization of settings
	P34: DATE	Date and time setting
	P35: PRINT	Test print

&lt;Channel 2&gt;

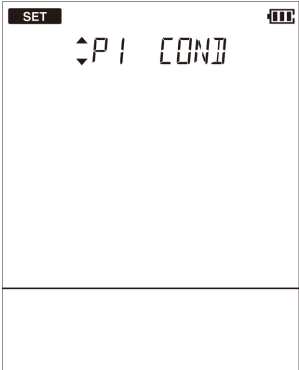
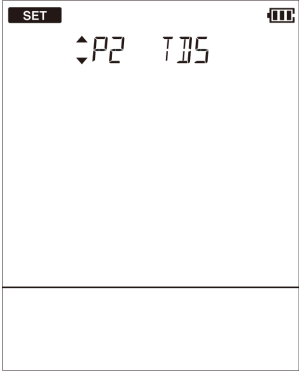
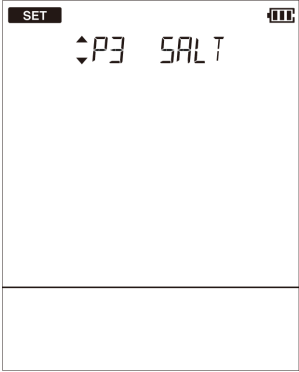
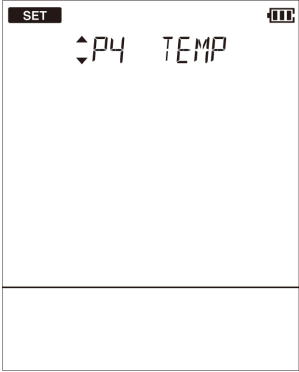
Screen	Layer	Description
	P1: COND	Conductivity measurement settings
	P11: CELL	Cell constant setting
	P12: UNIT	Selection of unit: S/cm, S/m, mS/cm FIX
	P13: CAL DATA	Calibration data display
	P14: AUTO CAL	Selection of auto calibration, manual calibration
	P15: CAL CLR	Deletion of calibration data
	P16: TEMP CF	Temperature conversion setting: 0.00%/°C to 10.00%/°C
	P17: TEMP REF	Reference temperature setting: 15°C to 30°C
	P2: TDS	TDS measurement settings
	P21: TDS TYPE	Selection of TDS calculation method: Linear, 442, En27888, NaCl
	P3: SALT	Salinity measurement settings
	P31: UNIT	Selection of unit: ppt, %
	P32: SALT TYP	Selection of salinity calculation method: NaCl, Sea water
	P4: TEMP	Temperature settings Selection of temperature conversion: ATC, MTC

## Basic operation

Screen	Layer	Description
	P5: GEN	General settings
	P51: MEAS	Selection of auto hold type: auto stability, auto hold
	P52: AUTO OFF	Automatic power off setting: 0 min to 30 min
	P53: RESET	Initialization of settings
	P54: DATE	Date and time setting
	P55: PRINT	Test print

## ● Changing the operation mode

Change the operation mode from four available modes depending on the purpose of use. The status icon indicates the current mode.

You can change the operation mode using the corresponding key. However changing to the calibration mode, data mode, or setting mode is possible only from the measurement mode. When changing to a different mode, first change to the measurement mode and then change to the desired mode.

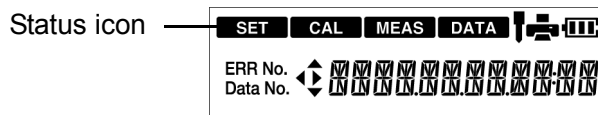

Icon	Name	Function
<b>MEAS</b>	Measurement mode	Performs measurement.
<b>CAL</b>	Calibration mode	Performs calibration.
<b>DATA</b>	Data mode	Performs data settings. Displays the saved data.
<b>SET</b>	Setting mode	Performs various settings.

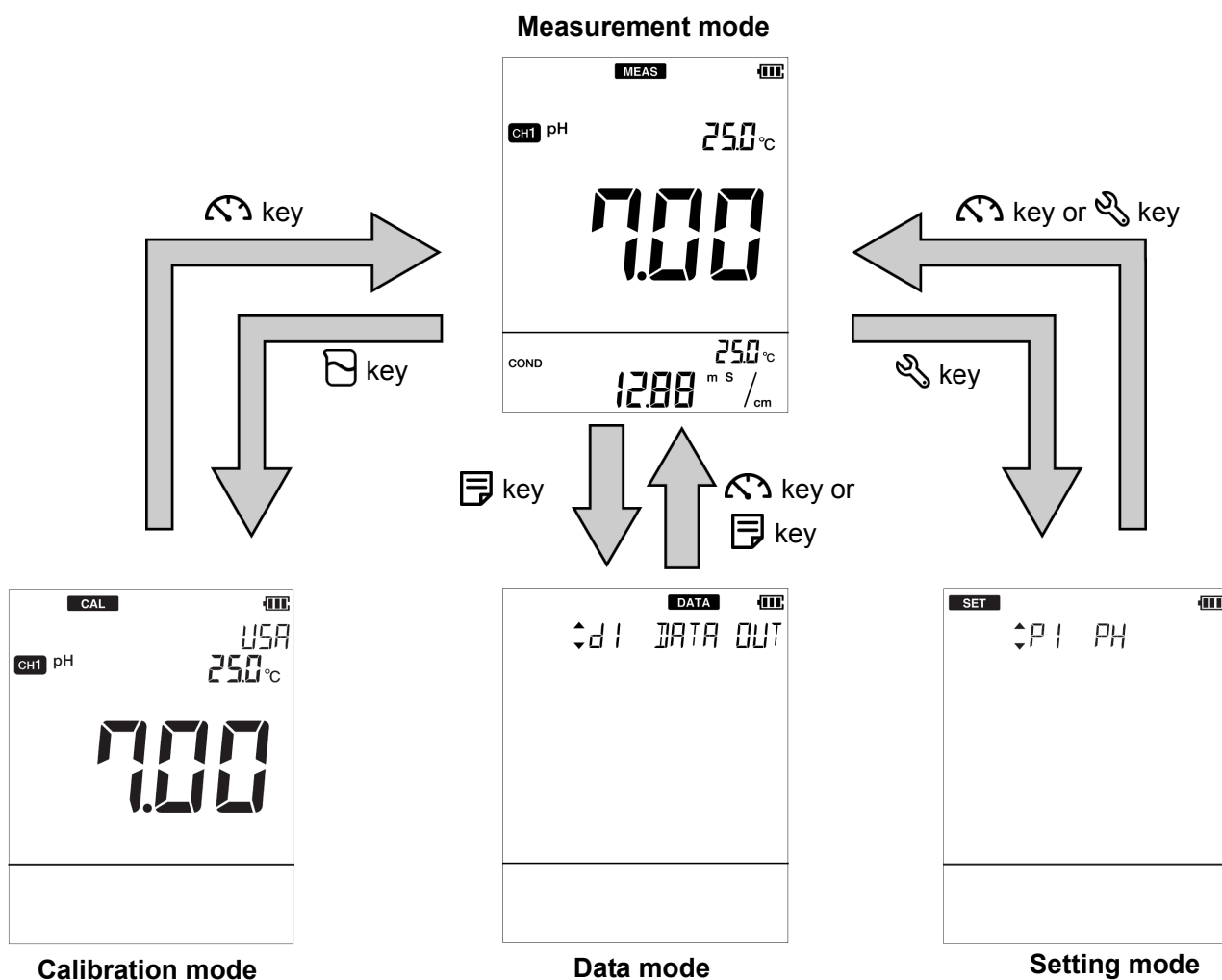

## ● Switching the displays

Switch the channel between the main screen and the sub screen.

In the measurement mode, pressing the ▲▼ key can switch the channels between the main screen and the sub screen.

When performing calibration or setting, switch the display to show the desired channel (measurement parameter) on the main screen.

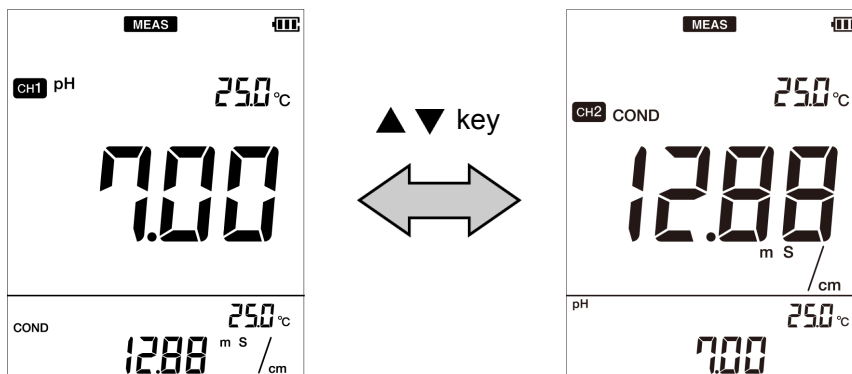



## ● Changing the measurement parameter

This instrument can measure multiple parameters. For measurement, an electrode corresponding to the measurement parameter is required. In the measurement mode, the measurement parameter can be changed by pressing the  key. This operation is available for the channel that is shown on the main screen.

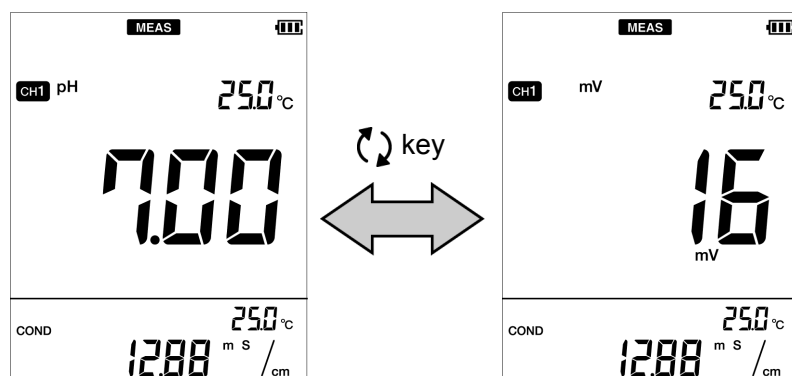

< Channel 1 >

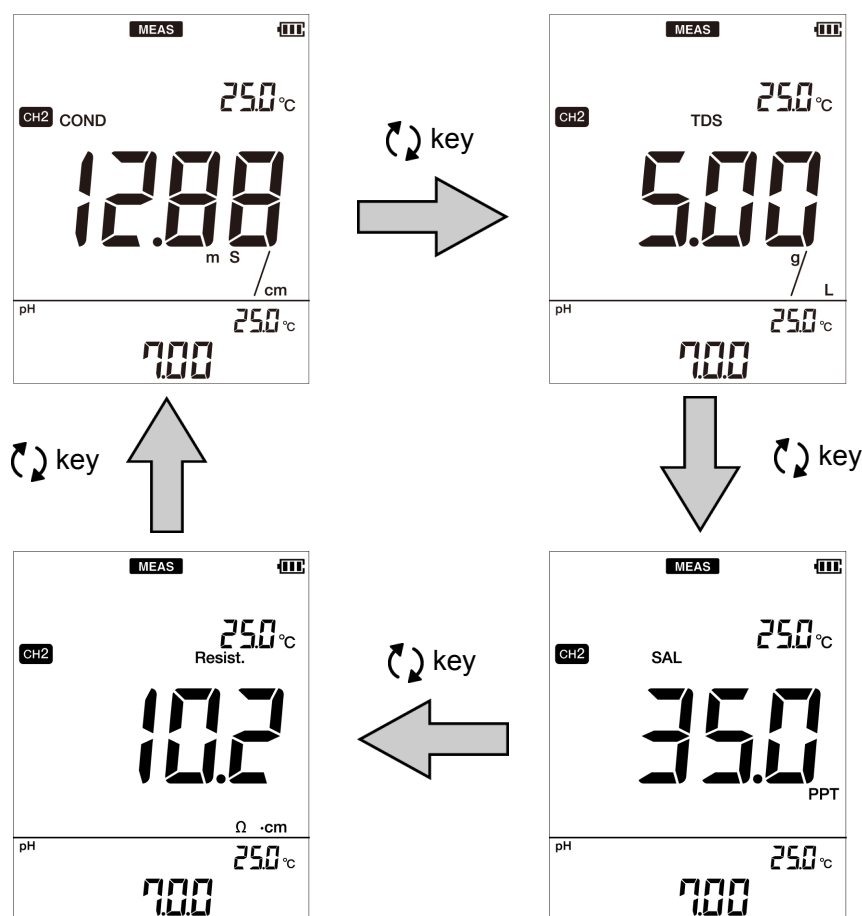

< Channel 2 >



## ● Using the backlight

When it is difficult to see the screen in a dark location, you can turn on the backlight by pressing the  key. If the backlight is not operated for 5 minutes, it automatically turns off. To turn it off manually, press the  key again while the backlight is on.

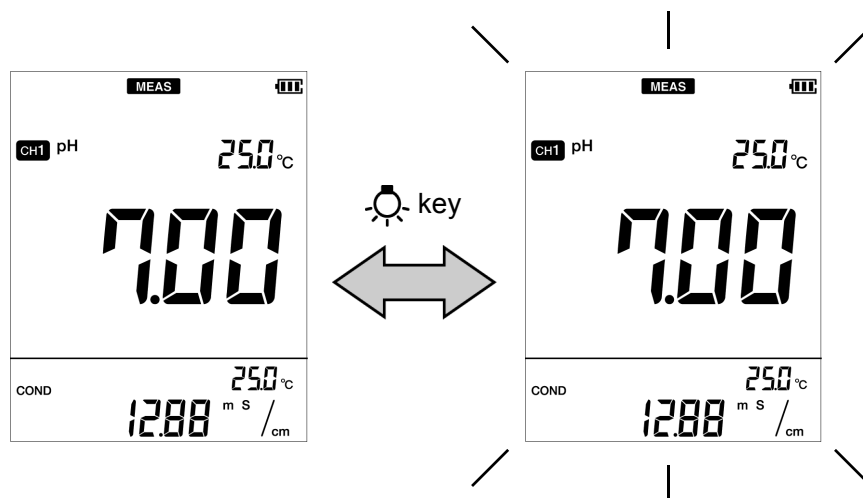

### Note

- Turning on the backlight consumes energy and shortens battery life.
- The backlight becomes unavailable when the battery level becomes low.

## ● Entering numeric values

When entering numeric values to make various settings and set a calibration value, change the selected digit using the ◀▶ keys and increment or decrement the value (0 to 9) using the ▲▼ keys.

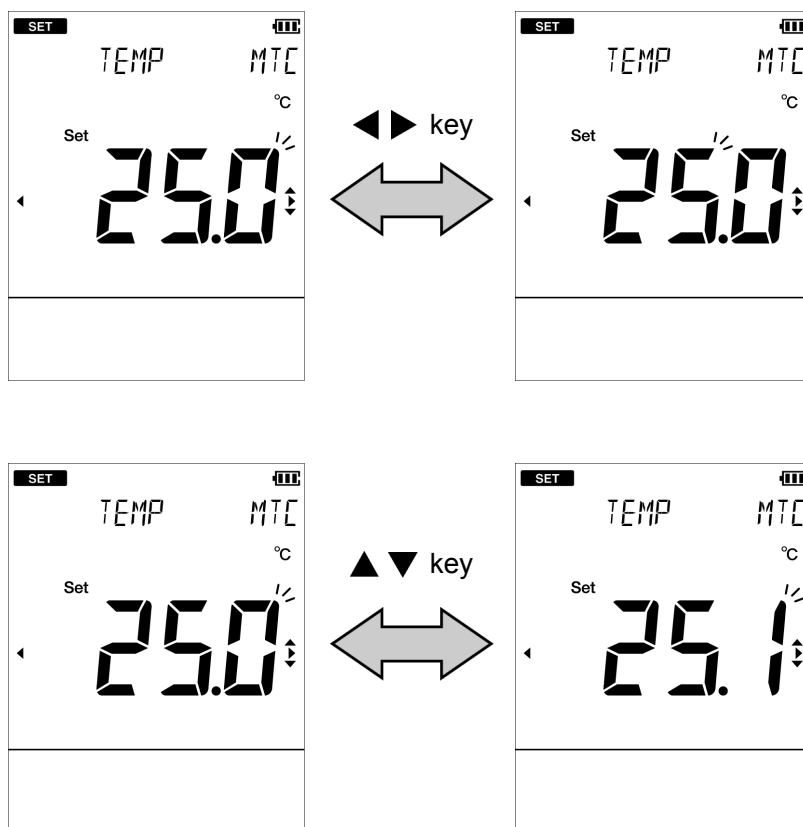

## ● Saving measurement data in the internal memory

Up to 1000 data items measured by the instrument can be stored in the internal memory. Saving the measurement data is possible only when the instrument is in the measurement mode.

### 1. Press the ● key while the data to save is displayed.

The saved data is displayed for two seconds and then the display returns to the previous screen automatically.

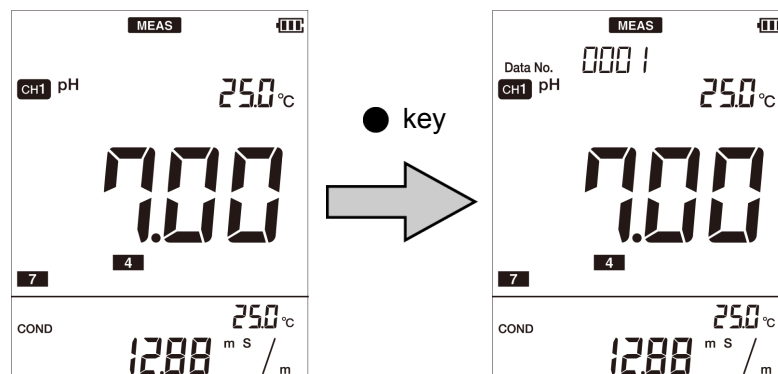

### Note

If the data saved reaches 1000 data items, an error occurs and "ERR No. 0010" is displayed. Copy or transfer necessary data to a PC and delete the data from the memory ("Deleting all saved data" (page 68)).

# Measurement

This section describes the basic measuring method of each measurement parameter.

■ Preparation .....	18
● Confirmation before starting measurement .....	18
● Turning ON the instrument.....	19
● Connecting an electrode .....	22
■ pH measurement.....	23
● Setting the instrument .....	23
● Performing calibration .....	27
● Performing measurement.....	35
● Saving measured value .....	36
■ mV, ORP measurement .....	37
● Switching between absolute value and relative value.....	37
● Performing measurement.....	38
● Saving measured value .....	39
■ Conductivity measurement.....	40
● Setting the instrument .....	41
● Performing conductivity calibration .....	57
● Performing measurement .....	61
● Saving measured values .....	62

## ■ Preparation

### ● Confirmation before starting measurement

- Have you prepared the appropriate electrode for the measurement parameter?  
⇒ If not, purchase the appropriate electrode.
  
- Is the prepared electrode in good condition?  
⇒ If the responsive part is stained or damaged, it may not be possible to obtain accurate values.
  
- Have you prepared the appropriate standard solution for the measurement parameter?  
⇒ If not, prepare the standard solution according to your applications.
  
- Are there any items that should not be wet or stained around the instrument?  
⇒ Depending on the operation during measurement, items around the instrument could get wet or stained. Secure sufficient space around the instrument and perform measurement while always paying attention to safety.
  
- Are there any devices that can be a source of noise?  
⇒ Measured values could be affected. Do not use the instrument near such devices.  
Always ground devices operated by AC power.

## ● Turning ON the instrument

### • Inserting the batteries

This instrument is operated by batteries. You can use AAA alkaline batteries or AAA Ni-MH rechargeable batteries. Perform the following procedure to insert batteries in the instrument.

1. Turn the knob on the battery cover on the back of the instrument counterclockwise to unlock the battery cover.

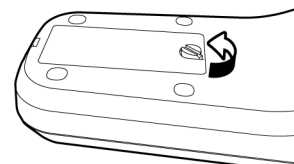

2. Remove the battery cover and set the batteries inside.

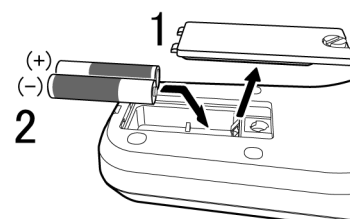

3. Put the battery cover back in.

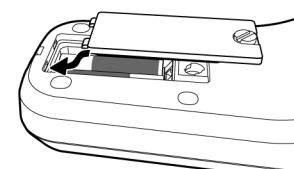

4. Turn the knob on the battery cover on the back of the instrument clockwise to lock the battery cover.

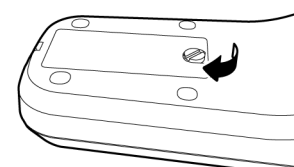

#### Note

- Do not replace the batteries in a dusty place or with wet hands. Dust or moisture could get inside the instrument, possibly causing instrument malfunction.
- Do not short-circuit a battery.
- Set the + and – side of the battery correctly.
- When the battery has run out or the instrument will not be used for a long time, remove the batteries.
- Of the specified battery types, make sure to use two batteries of the same type.
- Do not use a new battery together with a used battery.
- When using the Ni-MH batteries, do not use a fully charged battery together with an insufficiently-charged battery.

### • Using the AC adapter (option)

It is possible to use the AC adapter to operate the instrument.

Perform the following procedure to connect AC adapter to the instrument.

The AC adapter is an option. To purchase it, contact your dealer. (Refer to "Options" (page 116).)

1. Open the AC adapter cover of the instrument.
2. Insert the AC adapter cable by fitting with the AC adapter jack of in the instrument.
3. Insert AC adapter into the electrical socket.

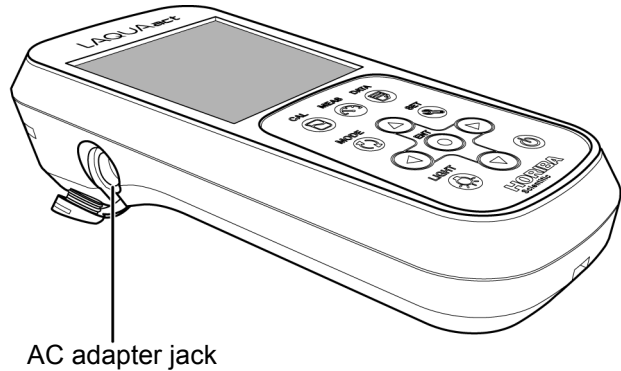

---

#### Note

- Do not insert the cable with force when the connector does not match the jack.
  - When not using the AC adapter, close the AC adapter connector cover.
  - While the AC adapter is connected, the instrument does not have the dust-proof and waterproof performance. Dust or moisture could get inside the instrument, possibly causing instrument malfunction.
-



## • Pressing the POWER key

After setting the batteries or connecting the AC adapter, press the  key over one second. The LCD is fully displayed for one second, and the screen displays the version number of software and the model, and then displays the measurement mode.

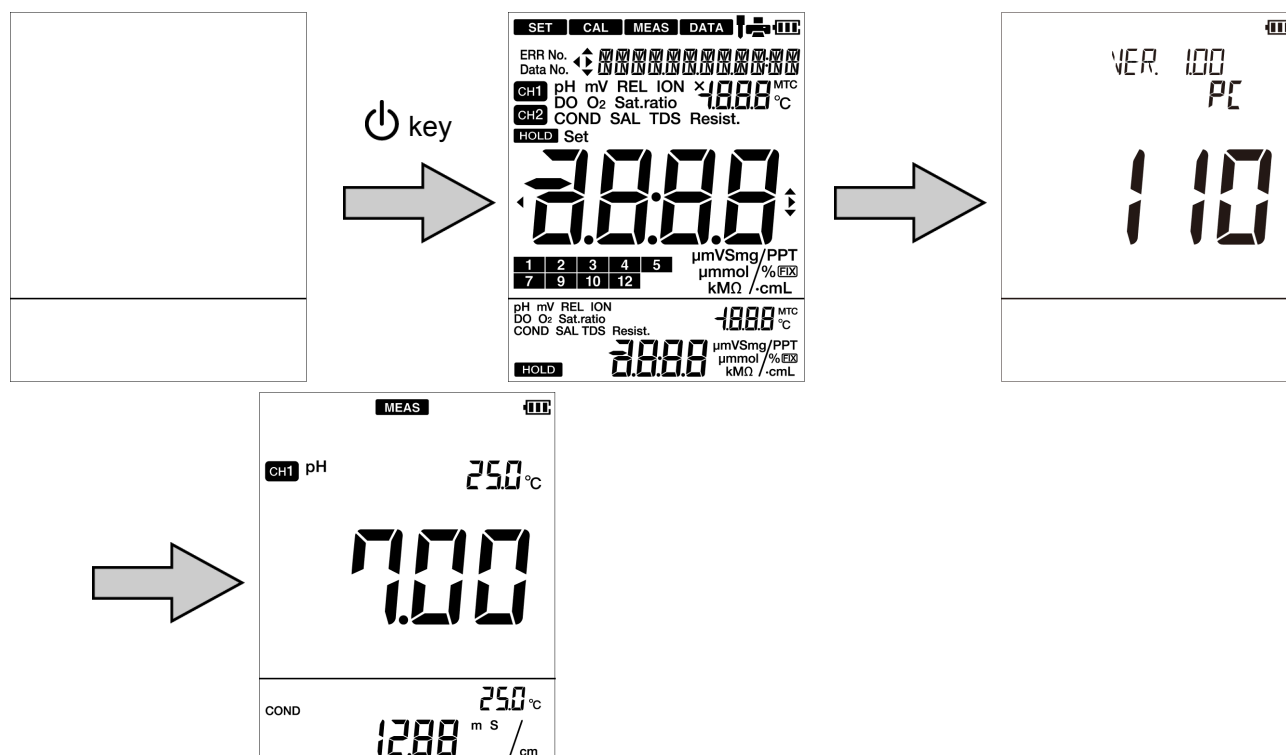

### Note

- Do not hold down the  key after the power of the instrument is turned ON.
- Do not use the tip of nail or an object with a sharp end to press keys.
- "VER" indicates the version of the software. It may be revised when the software is updated.

## ● Connecting an electrode

To perform measurement, it is necessary use the appropriate electrode for measurement parameters. Recommended electrodes for each measured sample are listed in our product catalog and on our website. Refer to them when preparing electrodes. Use the following procedure to correctly connect the electrode to the instrument.

1. Insert the electrode connector by fitting its groove with the connector pin of the instrument.

2. Turn the electrode connector clockwise by following the groove.

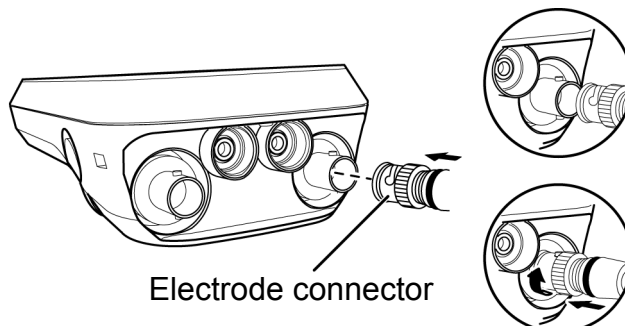

3. Put the connector cover on the connector.

4. When using a combination electrode equipped with a temperature sensor, insert the temperature connector (T) into the jack of the temperature connector (T).

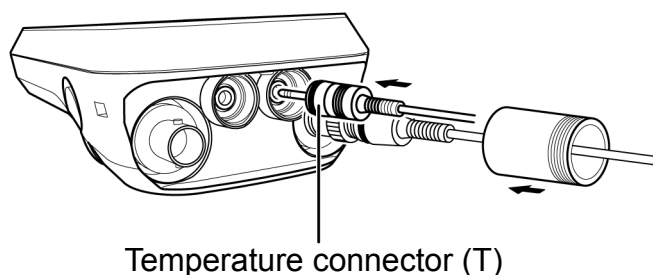

---

### Tip

If the temperature connector (T) is unconnected or connection is wrong, temperature selected for MTC (manual temperature compensation) is displayed as the sample temperature.

---

Preparation for measurement is complete.

For details of the measurement operation, refer to the following pages.

## ■ pH measurement

You can measure the pH of the sample with a pH electrode.

Use a combination electrode incorporating a glass electrode and a reference electrode for measurement. A single glass electrode cannot be used with this instrument.





pH can be measured using channel 1 of the instrument.

## ● Setting the instrument

### • Setting temperature compensation

Automatic temperature compensation function can be used by using a combination electrode equipped with a temperature sensor or connecting a temperature compensation electrode. By measuring temperature during calibration of the pH standard solution and compensating for the change in pH value of the standard solution due to its temperature changes, you can perform calibration using the value matched to the standard solution temperature (only when the standard solution setting is NIST and USA). However, the function does not convert the pH value according to the temperature characteristics of each sample, and you must record the obtained value together with the sample temperature value. The variation of pH value accompanying the temperature change differs depending on the sample.

If you do not use the automatic temperature compensation function, match the temperature setting of the instrument to the temperature of the standard solution during calibration and match the sample temperature to the temperature setting of the instrument in measurement. By doing so, you can obtain the correct measurement value without being affected by sensitivity variation caused by temperature.

1. Press the  key to enter the setting mode.
2. Press the   keys to select "TEMP" (temperature setting) and then press the  key.

If the temperature connector (T) is connected, "ATC" (automatic temperature compensation) appears. If the temperature connector (T) is not connected, "MTC" (manual temperature compensation) appears.

In the case of "ATC", you can calibrate the temperature sensor (refer to "Calibrating temperature sensor" (page 77)).

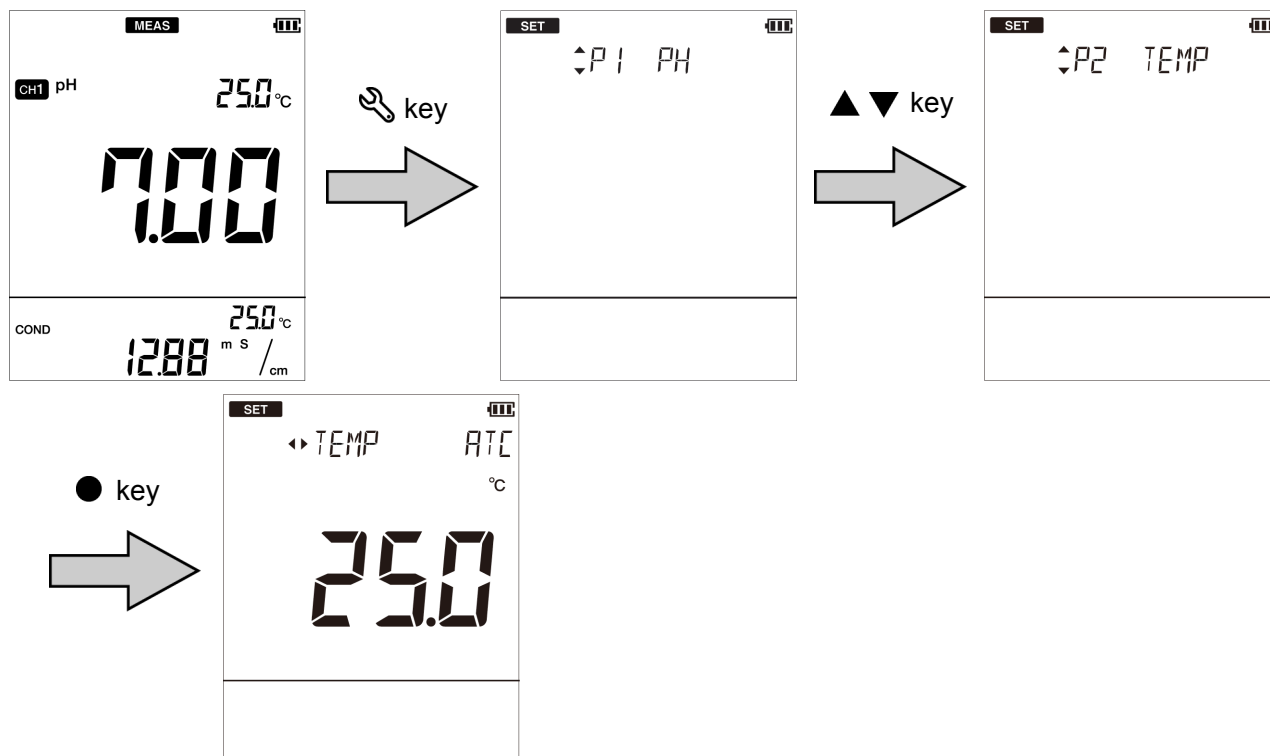



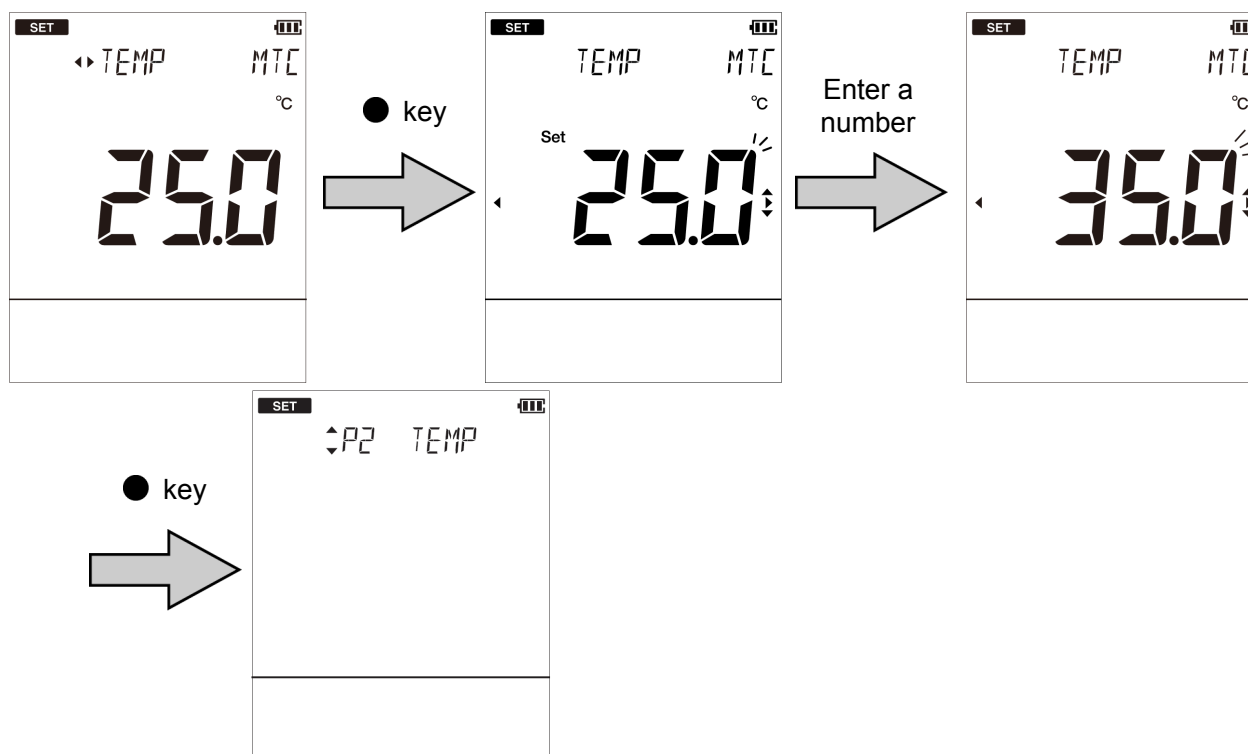

3. In the case of "MTC", enter the temperature to be compensated for and press the ● key to confirm.



To return to the measurement mode, press the key (represented by a circular arrow icon).

- **Setting the standard solution used for calibration (default: USA)**

Set the standard solution used for calibration. With this instrument, you can choose from 3 types, USA, NIST, and CUST (the standard solution other than USA and NIST). Set according to the standard solution to be used.

1. Press the  key to enter the setting mode.
2. Press the   keys to select "pH" (pH setting) and then press the  key.
3. Select "BUF" (pH standard solution setting) and then press the  key.

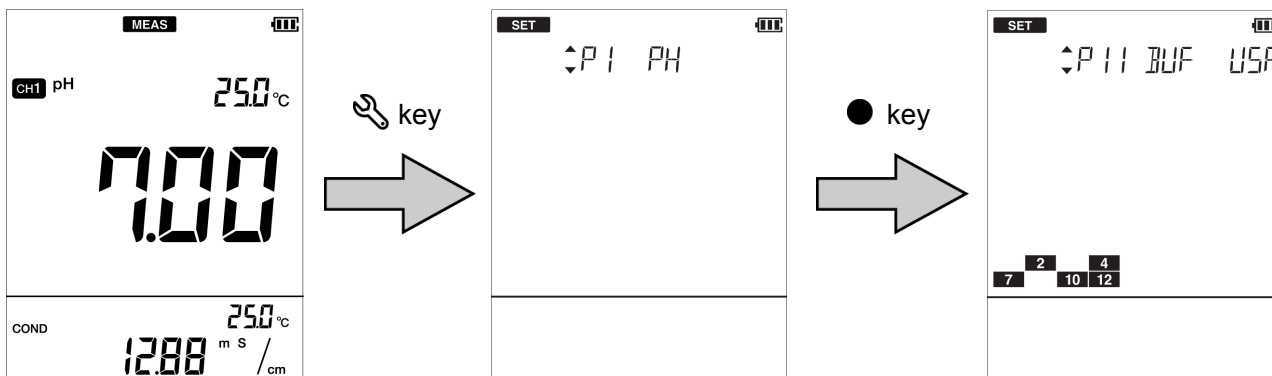

4. Press the ◀▶ keys to select "USA", "NIST", or "CUST" according to the standard solution to be used and then press the ● key to confirm selection.

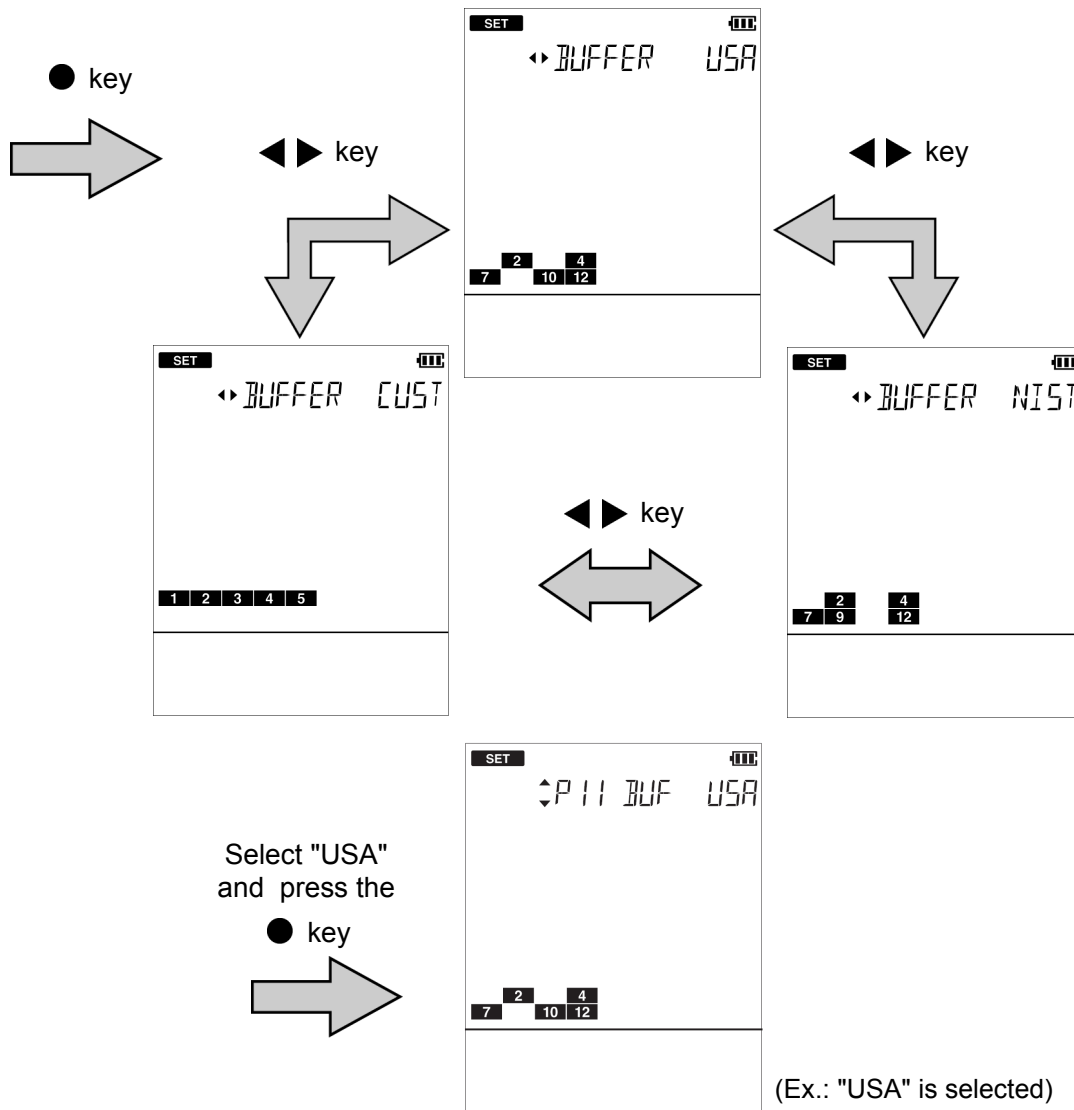

To return to the measurement mode, press the ↶ key.

• Standard solution type

Standard solution type	Description				
USA (USA specification)	Set to use the standard solution of the USA specification.				
	Standard solution icon				
	<b>2</b>	<b>4</b>	<b>7</b>	<b>10</b>	<b>12</b>
	1.68	4.01	7.00	10.01	12.45
NIST (NIST specification)	Set to use the standard solution of the NIST specification.				
	Standard solution icon				
	<b>2</b>	<b>4</b>	<b>7</b>	<b>9</b>	<b>12</b>
	1.68	4.01	6.86	9.18	12.45
CUST (custom specification)	Set to use the standard solution of an optional specification.				
	Standard solution icon <b>1 2 3 4 5</b>				

## ● Performing calibration

Calibration is necessary to measure pH accurately.

We recommend performing calibration once a day, before the first measurement.

According to the following procedure, perform calibration accurately.

### Note

- Perform two-point calibration using pH 7 and pH 4 when you know that the sample is acidic; pH 7 and pH 10 when you know that the sample is alkaline.
- Perform three-point calibration using pH 4, pH 7, and pH 10 when the sample is unknown.
- You can confirm the current calibration data in the setting mode and delete the calibration data in the setting mode. (Refer to "Displaying the latest calibration and inspection data" (page 70), "Deleting calibration data" (page 75).)

### • pH standard solution setting is USA or NIST

This section describes the procedure for two-point calibration of USA standard, pH 4 and 7, as an example of general calibration.

1. **Clean the pH electrode with pure water (or deionized water) and wipe it with filter paper or tissue paper.**

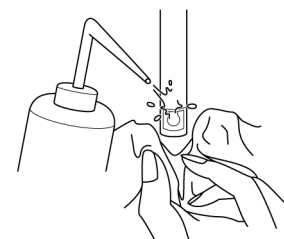

2. **Open the internal solution filler port of the pH electrode.**

If calibration is performed with the port closed, the internal solution does not flow and the measurement value is not stable. Make sure to keep the port open during calibration.

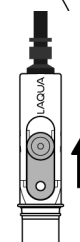

3. **Perform the 1st point calibration. Immerse at least 3 cm from the tip of the pH electrode in the pH 7 standard solution.**

In order for the internal solution to flow into the standard solution, make sure to immerse the liquid junction in the standard solution surely.

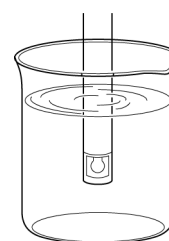

4. **Press the  key to enter the calibration mode.**

Stability judgment automatically starts and the pH icon blinks until the measured value stabilizes. When the measured value stabilizes, the pH icon changes from the blinking state to the lit state.

### Tip

The standard solution type for the calibration is shown on the upper right screen.

5. Press the  key or the  key.

Calibration to the standard solution value at the measured temperature is performed. The 1st point calibration ends and "7" calibration history icon lights, indicating that pH 7 calibration is complete.

The display automatically returns to the measurement screen.

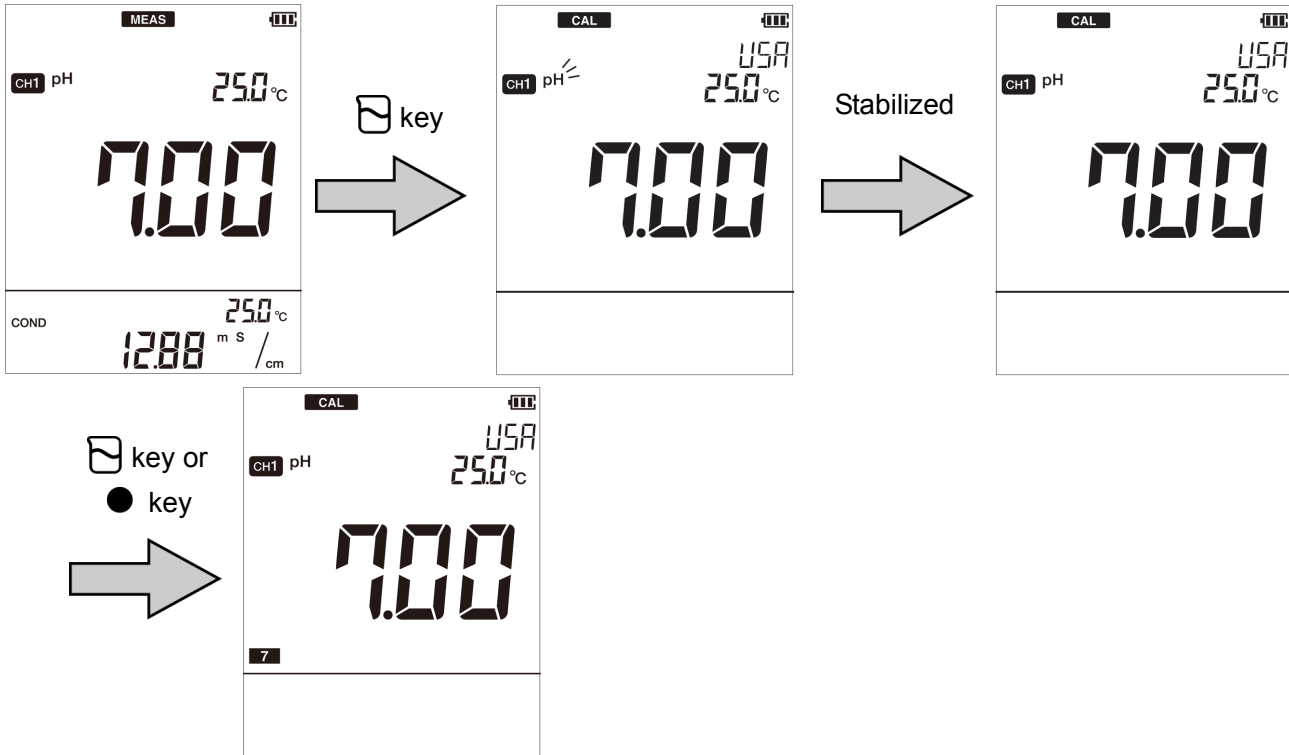

6. Perform the 2nd point calibration. As with the step 1., clean the pH electrode and immerse it in the pH 4 standard solution. As with the step 3., immerse at least 3 cm from the tip of the pH electrode.

7. Press the  key to enter the calibration mode.

Stability judgment automatically starts and the pH icon blinks until the measured value stabilizes. When the measured value stabilizes, the pH icon changes from the blinking state to the lit state.

8. Then press the  key or the  key.

Calibration to the standard solution value at the measured temperature is performed. The 2nd point calibration ends and "4" calibration history icon lights, indicating that pH 4 calibration is complete.

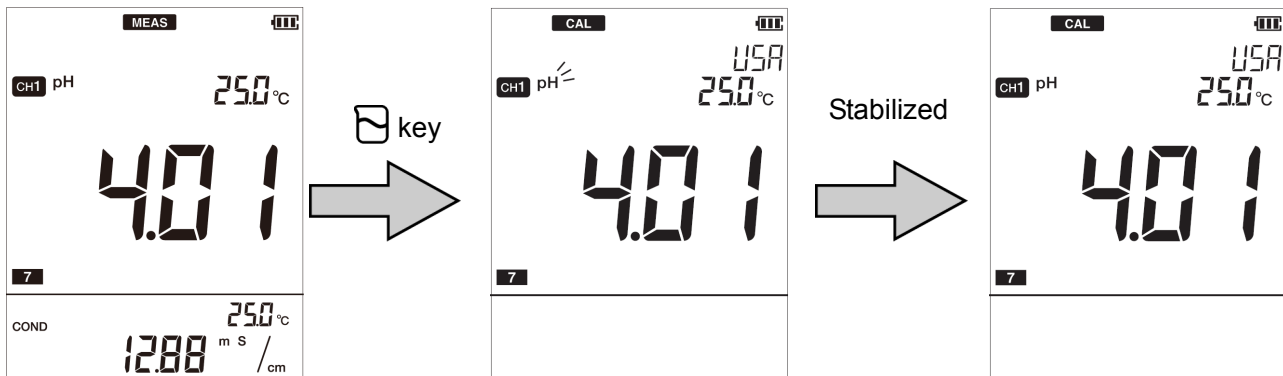



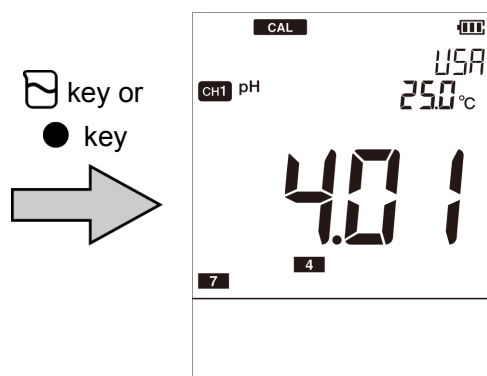

Two-point calibration is complete.

When calibrating three points or more, use the same procedure to continue calibrating the 3rd and subsequent points after the 2nd point calibration. You can calibrate up to five points. Also, you can inspect repeatability using the pH 7 standard solution. About the repeatability inspection procedure, refer to "Inspecting repeatability" (page 30).

#### Tip

The order of calibration of the standard solution is optional.

In the above example, you can calibrate pH 4 first and then pH 7.

#### Note

- If calibration of any standard solution is performed again, only the value of calibrated solution is updated. If calibration is repeated, only the calibration value of used standard solution is updated. The calibration values are retained until next calibration is performed, the data is deleted or buffer setting is changed. For the procedure for deleting the calibration data, refer to "Deleting calibration data" (page 75).
- It is recommended that you should clear the previous calibration data before the calibration in order to perform more accurate calibration.

### •Check of the pH electrode status

After calibration is complete, the current pH electrode status is diagnosed from the calibration result. Refer to the following table for maintenance of the electrode.

Display	Description	Reference
Both $\downarrow$ and ERR No. are not displayed	Electrode sensitivity: 85% to 100% Good condition.	—
ERR No.0004 $\downarrow$ blinks	Asymmetry potential: less than $-45$ mV or excess 45 mV Maintain or replace the electrode.	P. 102
ERR No.0005 $\downarrow$ blinks	Sensitivity: less than 85% or excess 105% Maintain or replace the electrode.	P. 103

• **Inspecting repeatability**

You can inspect repeatability using the pH 7 standard solution by returning to the calibration screen after calibration and ends and pressing the  key. Measure the pH 7 standard solution by using the calibrated electrode to display the absolute value of the difference between the measured value and standard solution value.

In order to inspect repeatability, you need to perform calibration of the pH 7 standard solution with either "USA" or "NIST" set as the standard solution.

- 1. Clean the calibrated pH electrode with pure water (or deionized water) and wipe it with filter paper or tissue paper.**

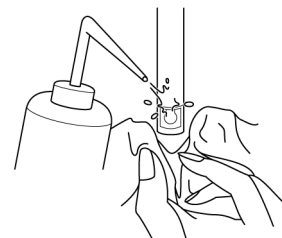

- 2. Open the internal solution filler port of the pH electrode.**

If calibration is performed with the port closed, the internal solution does not flow and the measurement value is not stable. Make sure to keep the port open during calibration.

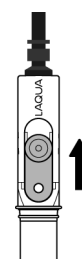

- 3. Perform the 1st point calibration. Immerse at least 3 cm from the tip of the pH electrode in the pH 7 standard solution.**

In order for the internal solution to flow into the standard solution, make sure to immerse the liquid junction in the standard solution surely.

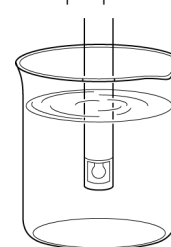

- 4. Press the  key to enter the calibration mode.**
- 5. Make sure that the pH icon lights while the pH electrode is immersed in the standard solution.**

Stability judgment starts and the pH icon blinks. When the value is stabilized, the pH icon changes from the blinking state to the lit state and the display is fixed to the measured value at the stable time.

6. Press the  key to start inspection.

"REP" (repeatability) is shown and display changes to the measurement mode.

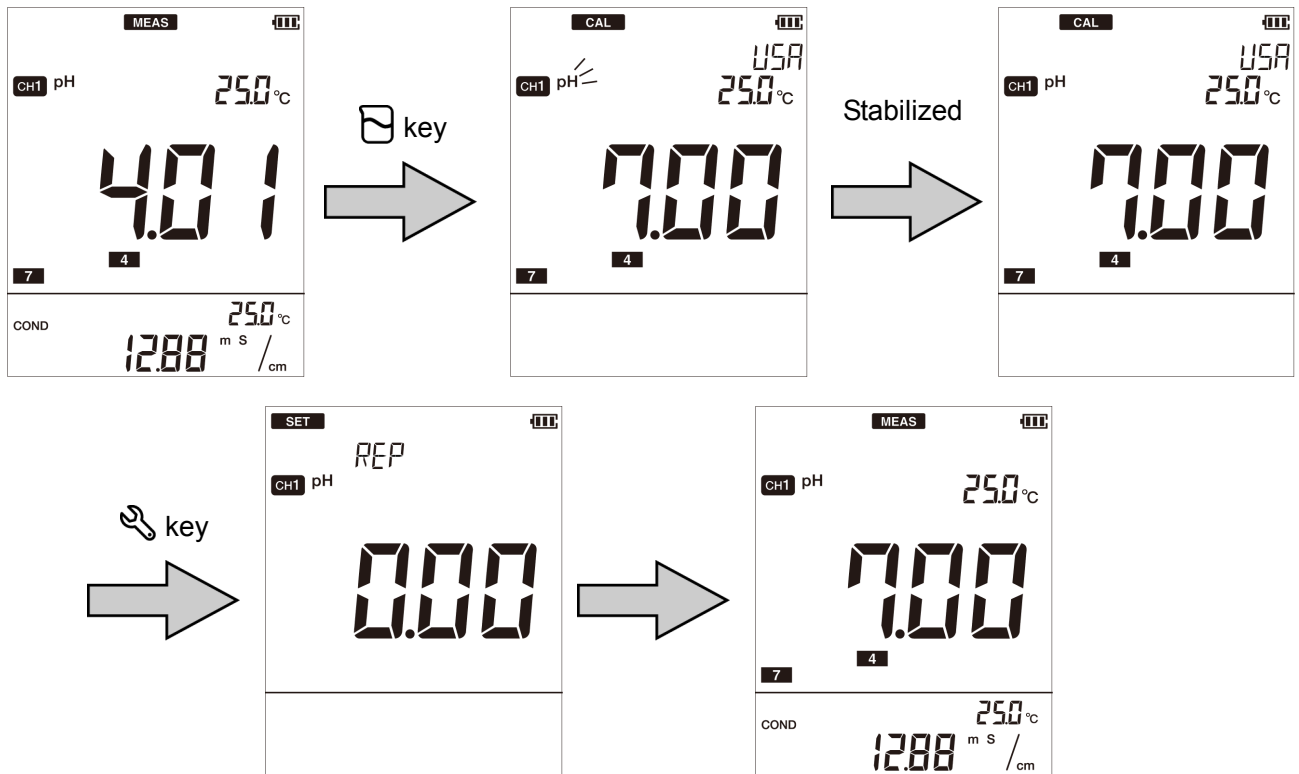

• pH standard solution setting is CUST

This section describes the procedure for two-point calibration.

1. Clean the pH electrode with pure water (or deionized water) and wipe it with filter paper or tissue paper.

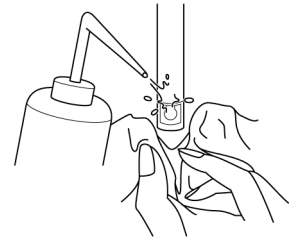

2. Open the internal solution filler port of the pH electrode.

If calibration is performed with the port closed, the internal solution does not flow and the measurement value is not stable. Make sure to keep the port open during calibration.

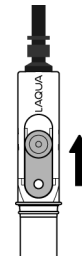

3. Perform the 1st point calibration. Immerse at least 3 cm from the tip of the pH electrode in standard solution.

In order for the internal solution to flow into the standard solution, make sure to immerse the liquid junction in the standard solution surely.

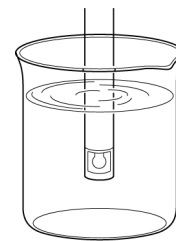

4. Press the  key to enter the calibration mode.

Stability judgment automatically starts and the pH icon blinks until the measured value stabilizes. When the measured value stabilizes, the pH icon changes from the blinking state to the lit state.

5. Enter the standard solution value and press the  key or the ● key.

Calibration to the set standard solution value is performed. The 1st point calibration ends and the "1" calibration history icon lights, indicating that 1st point calibration is complete.

The display returns to the measurement screen.

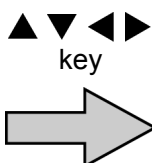
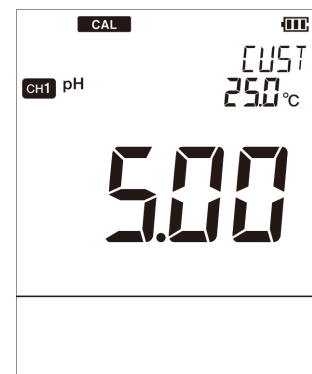
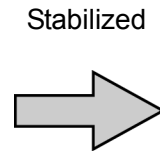
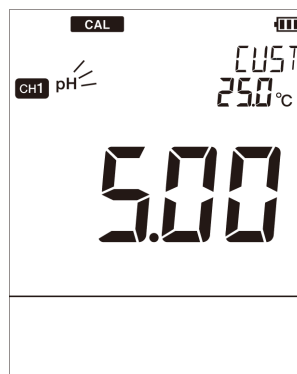
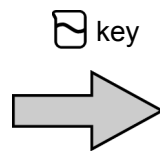



6. Perform the 2nd point calibration. As with the step 1., clean the pH electrode and immerse it in the 2nd standard solution. As with the step 3., immerse at least 3 cm from the tip of the pH electrode.

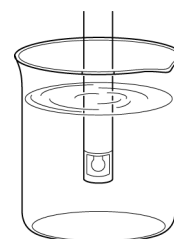

7. Press the  key to enter the calibration mode.

Stability judgment automatically starts and the pH icon blinks until the measured value stabilizes. When the measured value stabilizes, the pH icon changes from the blinking state to the lit state.

8. Enter the standard solution value for the second point and press the  key or the  key.

Calibration to the set standard solution value is performed. The 2nd point calibration ends and the "2" calibration history icon lights, indicating that 2nd point calibration is complete.

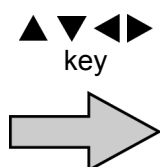
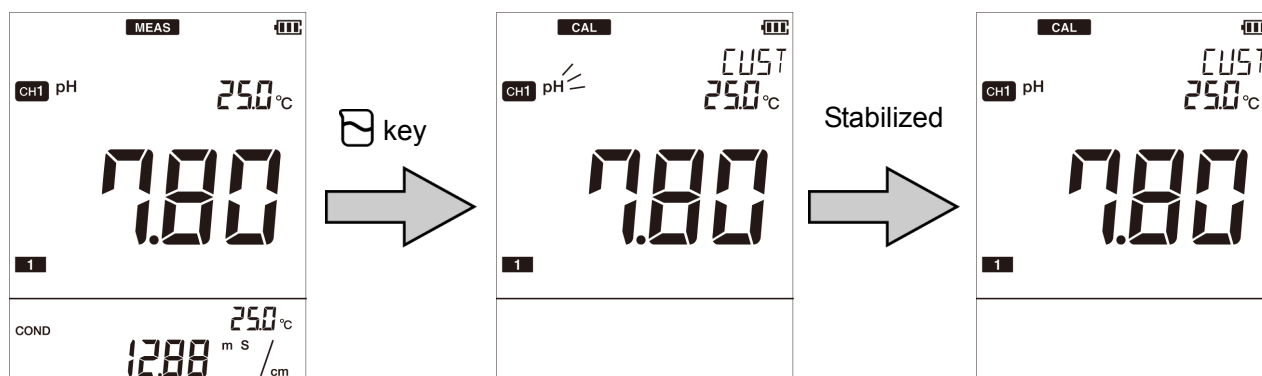

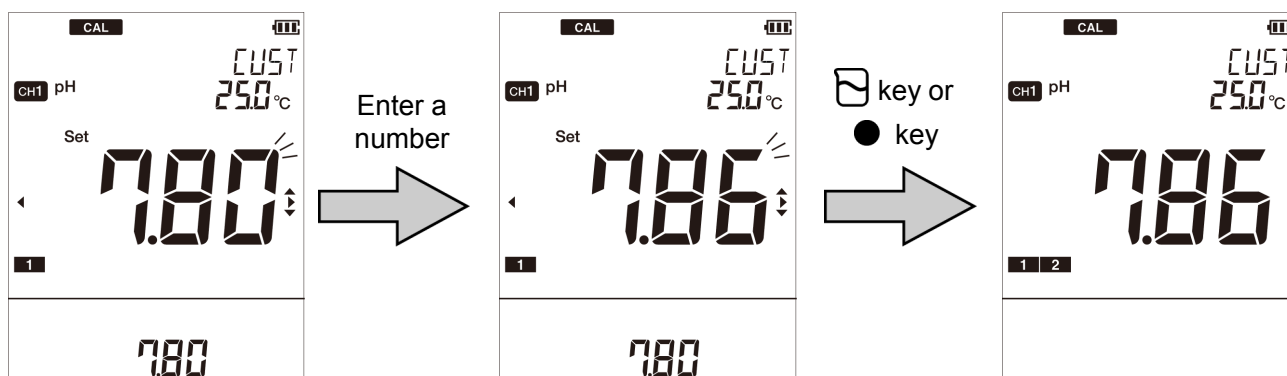

Two-point calibration is complete.

When calibrating three points or more, use the same procedure to continue calibrating the 3rd and subsequent points after the 2nd calibration. You can calibrate up to five points.

**Note**

- If calibration of any standard solution is performed again, only the value of calibrated solution is updated. If calibration is repeated, only the calibration value of used standard solution is updated. The calibration values are retained until next calibration is performed or the data is deleted. For the procedure for deleting the calibration data, refer to "Deleting calibration data" (page 75).
- It is recommended that you should clear the previous calibration data before the calibration in order to perform more accurate calibration.

**•Check of the pH electrode status**

After calibration is complete, the current pH electrode status is diagnosed from the calibration result. Refer to the following table for maintenance of the electrode.

Display	Description	Reference
Both  and ERR No. are not displayed	Electrode sensitivity: 85% to 100% Good condition.	—
ERR No.0004 blinks	Asymmetry potential: less than -45 mV or excess 45 mV Maintain or replace the electrode.	P. 102
ERR No.0005 blinks	Sensitivity: less than 85% or excess 105% Maintain or replace the electrode.	P. 103

## ● Performing measurement

You can perform measurement in the measurement mode by immersing the pH electrode in the sample. You can use the automatic hold function to judge the stability of the measured value. The automatic hold function has two modes, the auto stability mode and the auto hold mode. For the instruction to set the mode, refer to "Setting the auto stability and auto hold function" (page 79).

1. **Clean the pH electrode with pure water (or deionized water) and wipe it with filter paper or tissue paper.**

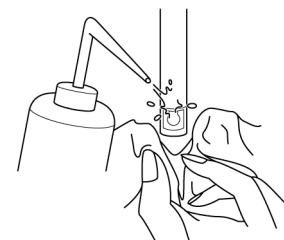

2. **Open the internal solution filler port of the pH electrode.**

If calibration is performed with the port closed, the internal solution does not flow and the measurement value is not stable. Make sure to keep the port open during calibration.

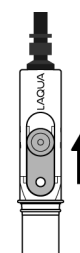

3. **Immerse at least 3 cm from the tip of the pH electrode in the sample solution.**

In order for the internal solution to flow into the sample solution, make sure to immerse the liquid junction in the sample solution surely.

Stability judgment automatically starts and the pH icon blinks until the measured value stabilizes. When the measured value stabilizes, the pH icon changes from the blinking state to the lit state and the display is fixed to the stabilized measured value.

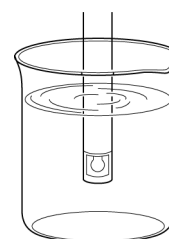

### • Auto stability mode

If the measurement pH value does not fulfill the stability condition, the fixed value is released. When the measured value fulfills the stability condition again, the measured value is fixed.

### • Auto hold mode

Press the  key to release the fixed measured value. When the measured value fulfills stability condition again, the measured value is fixed.

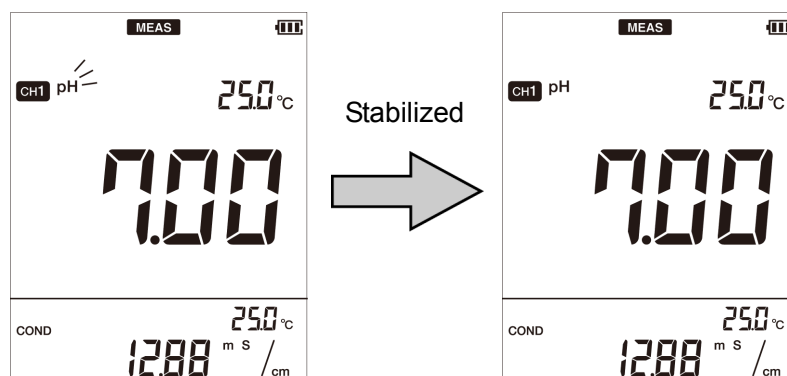

#### Note

- The criteria of stability judgment in the auto hold measurement are as follows.  
Potential variation for 10 seconds is less than 1 mV (0.015 pH equivalent) and temperature variation is less than 2.0°C
- If the measured value is below the display range, "Ur" (under) appears. If the measured value is above the display range, "Or" (over) appears. For details on the action to take, refer to "The measured value is out of the measurement range" (page 107).

### ● Saving measured value

To save the measurement data, press the  key in the screen that you want to save. For details, refer to "Saving measurement data in the internal memory" (page 16).



## ■ mV, ORP measurement

You can measure the electromotive force between the electrode and the sample by using a pH electrode. The mV value can be used to understand the status of the electrode in the mV measurement.

You can measure the ORP (oxidation-reduction potential) of the sample by using an ORP electrode in the ORP measurement.

In the measurement mode, press the  key to change the measurement parameter to "mV".

mV and ORP can be measured using channel 1 of the instrument.

## ● Switching between absolute value and relative value



There are two types of measurement mode for the mV and ORP measurement, the absolute value measurement and the relative value measurement.

- Absolute value measurement mode

The measured value of electromotive force is displayed.

- Relative value measurement mode

The measured value of electromotive force of a sample is corrected to 0 mV and set as a relative value. When the electromotive force of another sample is measured, the difference value between the relative value and the measured value is displayed.

The default mode is the absolute value measurement mode. Pressing the  key switches to the relative value measurement mode. Pressing the  key again returns to the absolute value measurement mode.

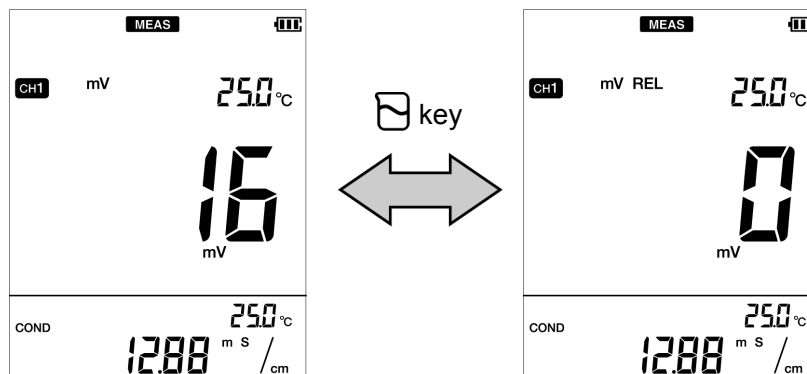

## ● Performing measurement

You can perform measurement in the measurement mode by immersing the pH electrode in the sample. Also, you can use the automatic hold function to judge the stability of the measured value. The automatic hold function has two modes, the auto stability mode and the auto hold mode. For how to set the mode, refer to "Setting the auto stability and auto hold function" (page 79).

1. Clean the electrode with pure water (or deionized water) and wipe it with filter paper or tissue paper.

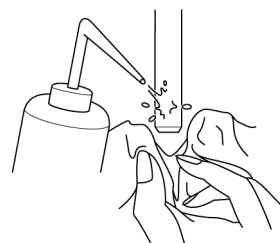

2. Open the internal solution filler port of the electrode.

If calibration is performed with the port closed, the internal solution does not flow and the measurement value is not stable. Make sure to keep the port open during calibration.

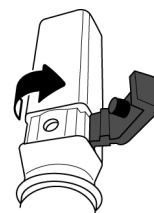

3. Immerse at least 3 cm from the tip of the electrode in the sample solution.

In order for the internal solution to flow into the sample solution, make sure to immerse the liquid junction in the sample solution surely.

Stability judgment automatically starts and the mV icon blinks until the measured value stabilizes. When the measured value stabilizes, the mV icon changes from the blinking state to the lit state, and the display is fixed to the stabilized measured value.

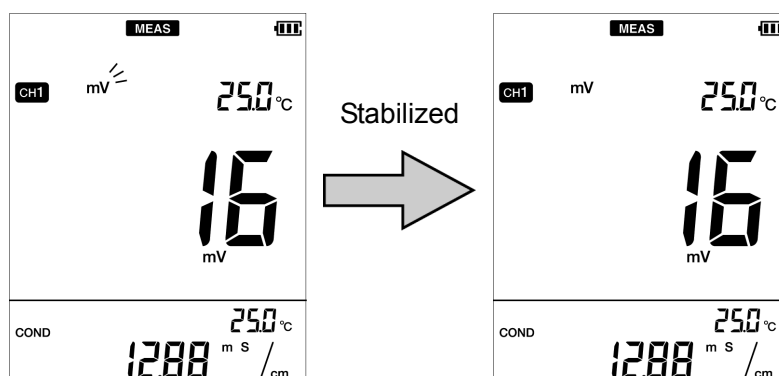
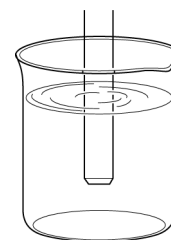

**Note**

- The criteria of stability judgment in the automatic hold measurement are as follows. Potential variation for 10 seconds is less than 1 mV and temperature variation is less than 2.0°C
  - If the measured value is below the display range, "Ur" (under) appears. If the measured value is above the display range, "Or" (over) appears. For details on the action to take, refer to "The measured value is out of the measurement range" (page 107).
  - Note that when measuring the ORP of a sample solution that has extremely low concentrations of oxidants and reductants (such as tap water, well water, or water treated with purifying equipment), there may be less responsiveness and repeatability in general.
  - If alkaline water is left, its ORP value changes considerably. Always measure alkaline ion water promptly.
- 



**● Saving measured value**

To save the measurement data, press the ● key in the screen that you want to save. For details, refer to "Saving measurement data in the internal memory" (page 16).

### ■ Conductivity measurement





The conductivity cell can be used to measure the conductivity, salinity, TDS, and resistivity of a sample. Salinity, TDS, and resistivity are calculated from the measured value of conductivity.

Press the  key to select the measurement parameter (refer to "Changing the measurement parameter" (page 13)).

Conductivity can be measured using channel 2 of the instrument. Press the   keys to set the main screen to channel 2.

The basic steps are the same for all measurement parameters, however, some settings and operations are only valid for specific measurement parameters. Select the settings and perform the steps that show the mark of the parameter you want to measure.





< Examples >

-  : Conductivity measurement
-  : Salinity measurement
-  : Total dissolved solids measurement
-  : Resistivity measurement
-  : All measurement parameters

## ● Setting the instrument

### • Setting the temperature display ALL

When a conductivity cell with a temperature sensor is used, or a conductivity cell without a temperature sensor is used with a temperature electrode, the automatic temperature measurement function can be used. During measurement, the temperature sensor measures the temperature of the sample and displays the result on the instrument. If automatic temperature measurement function is not used, or the temperature connector is not connected to the instrument, the temperature set in the instrument is displayed.

1. Press the  key to enter the setting mode.
2. Press the   keys to select "TEMP" (temperature setting) and then press the  key.

If the temperature connector (T) is connected, "ATC" (automatic temperature compensation) appears. If the temperature connector (T) is not connected, "MTC" (manual temperature compensation) appears.

In the case of "ATC", the temperature sensor can be calibrated (refer to "Calibrating temperature sensor" (page 77)).

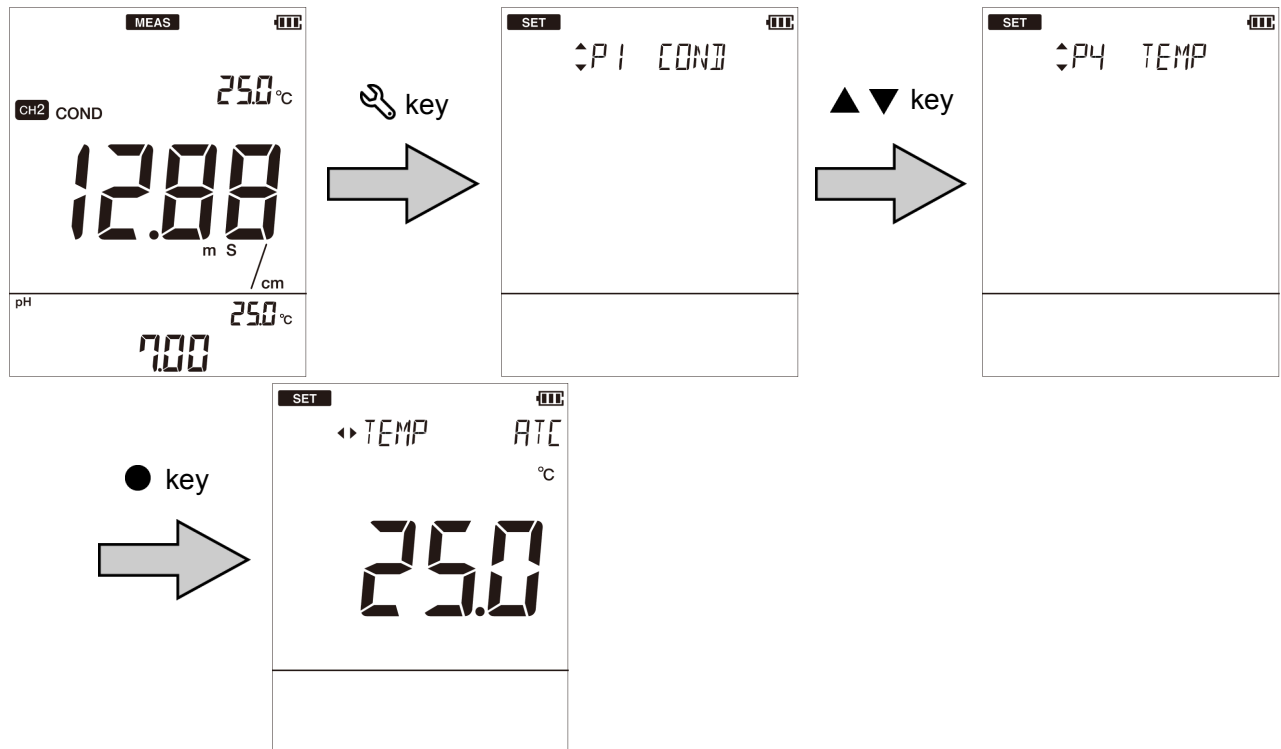

3. In the case of "MTC", enter the temperature to be compensated for and press the ● key to confirm.

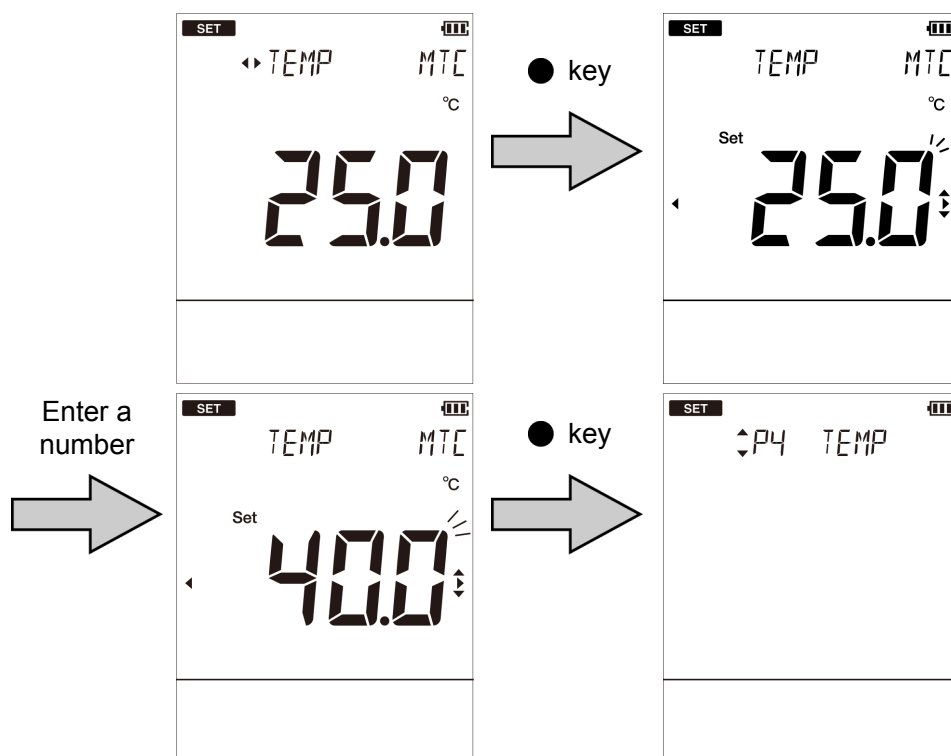







To return to the measurement mode, press the  key.

• **Setting the conductivity unit (default: S/cm) COND RESIST**

Select the conductivity unit from three options, S/cm, S/m, mS/cm FIX (fixed at mS/cm) depending on your application.

When measuring resistivity, these units correspond to  $\Omega \cdot \text{cm}$ ,  $\Omega \cdot \text{m}$ ,  $\Omega \cdot \text{cm}$  (for mS/cm FIX).

1. Press the  key to enter the setting mode.
2. Press the   keys to select "COND" (conductivity setting) and then press the  key.
3. Press the   keys to select "UNIT" (unit setting) and then press the  key.

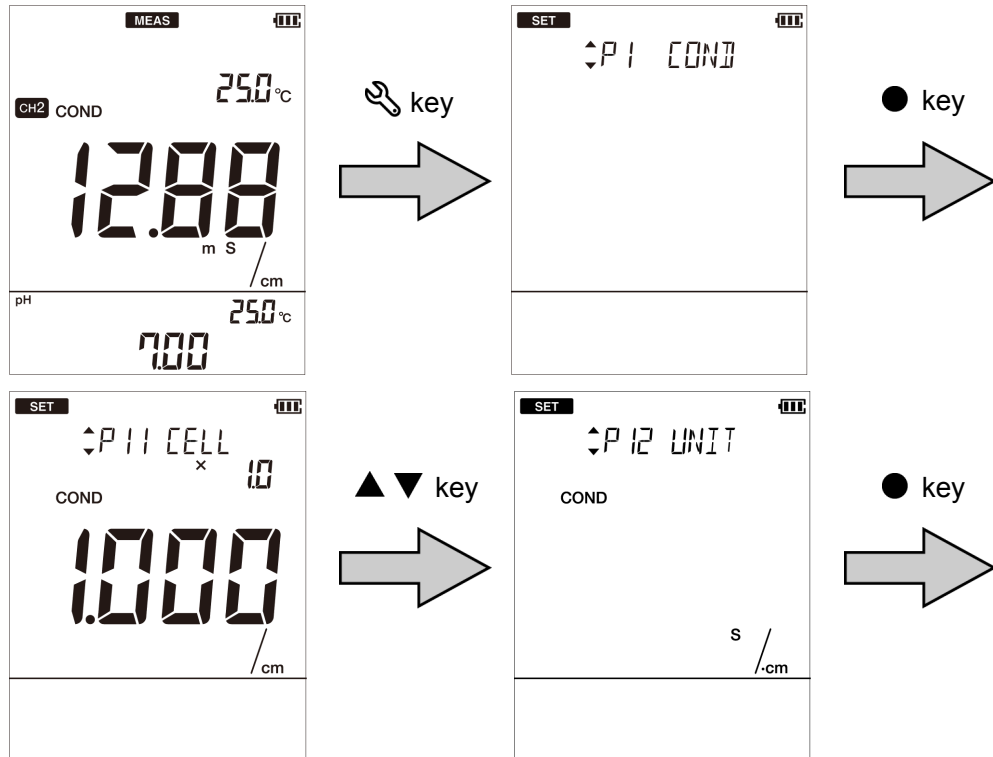

4. Press the ◀▶ key to select the unit and press the ● key to confirm selection.

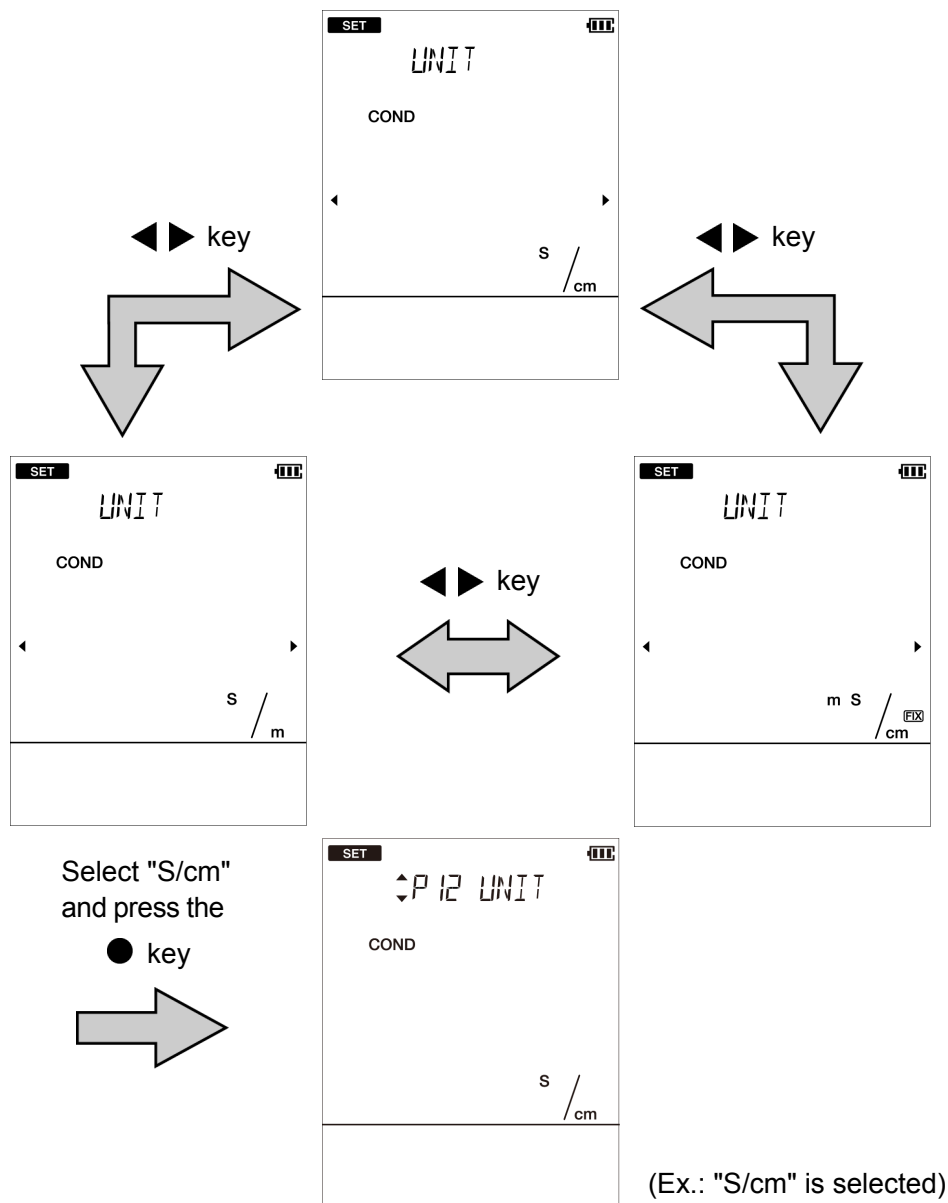







To return to the measurement mode, press the ⏪ key.



• **Setting the salinity unit (default: PPT) SAL**

Select the salinity unit from % or PPT depending on your application.

1. Press the  key to enter the setting mode.
2. Press the   keys to select "SALT" (conductivity setting) and then press the  key.
3. Press the   keys to select "UNIT" (unit setting) and then press the  key.

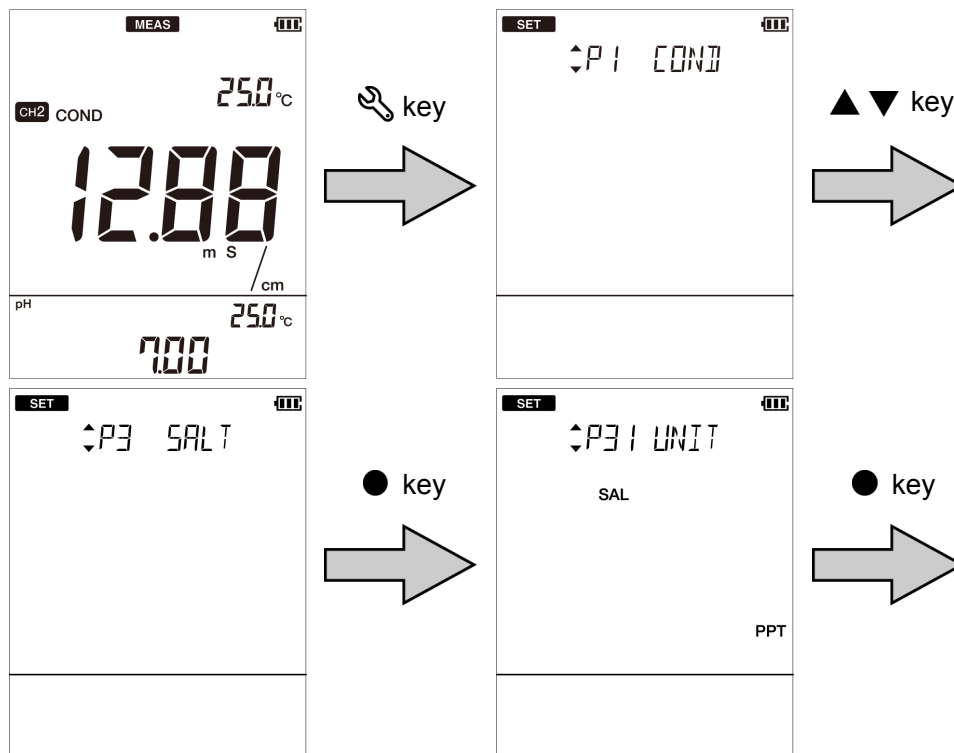



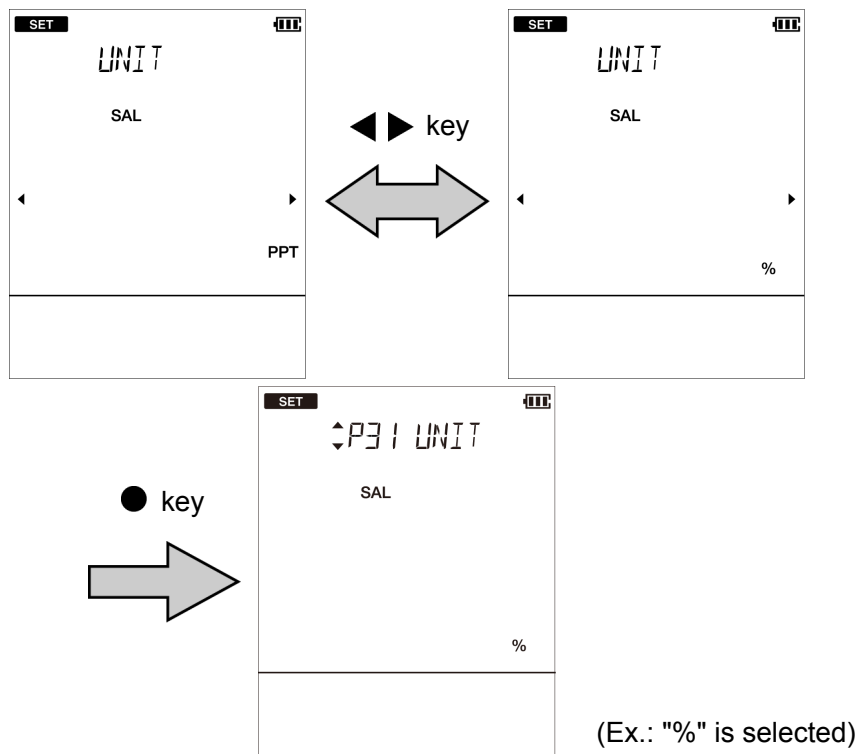



4. Press the ◀▶ keys to select the unit and then press the ● key to confirm selection.



To return to the measurement mode, press the ↻ key.

**• Setting the cell constant (default:  $1.000 \times 1.0 \text{ cm}^{-1}$ )** ALL

A cell constant is unique for each conductivity cell. To measure conductivity correctly, the cell constant of the conductivity cell must be set in the instrument.

1. Press the  key to enter the setting mode.
2. Press the   keys to select "COND" (conductivity setting) and then press the  key.
3. Press the   keys to select "CELL" (cell constant setting) and then press the  key.

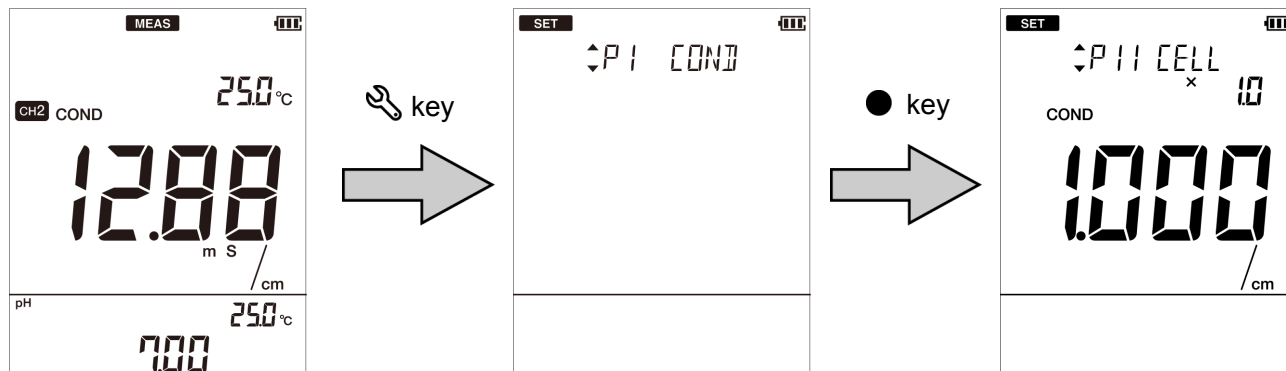

4. Press the ◀▶ keys to select the digit number of the cell constant of the conductivity cell and then press the ● key.

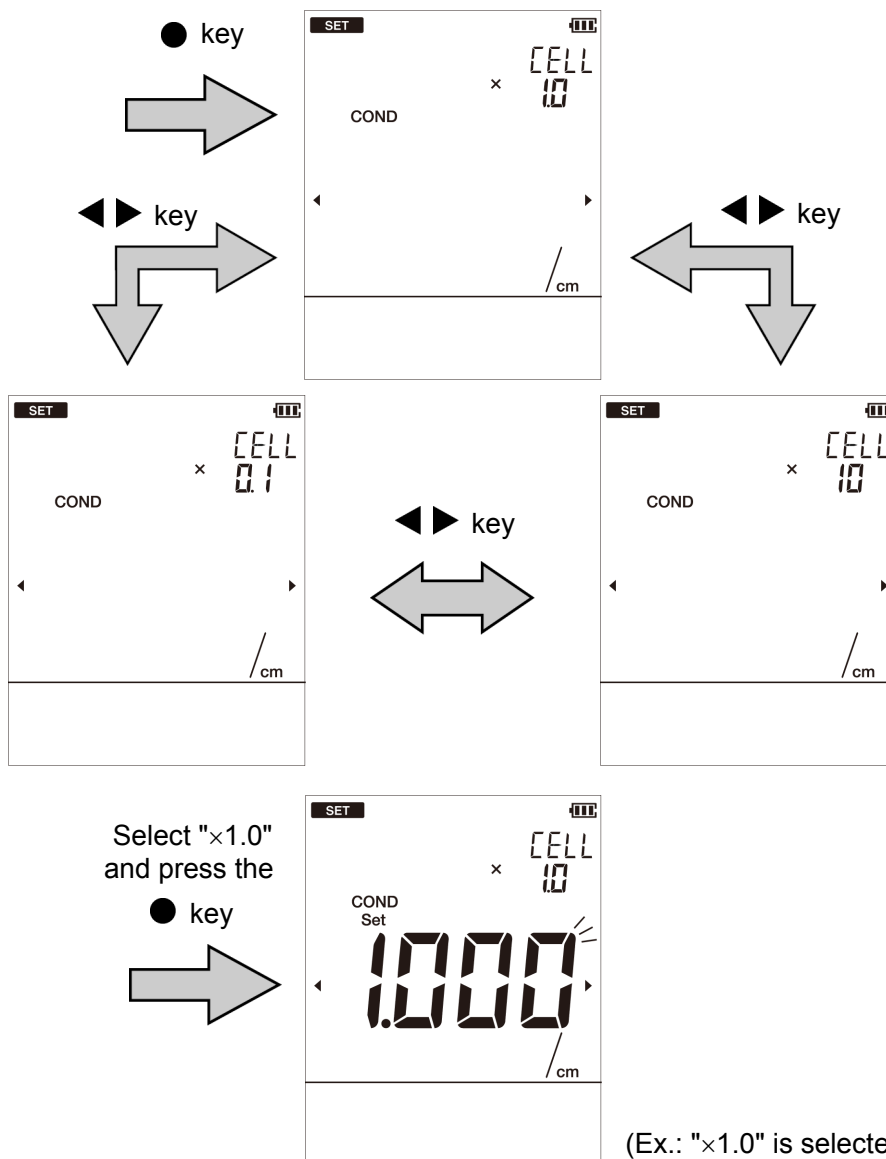

5. Press the ▲▼◀▶ keys to enter the cell constant value of the conductivity cell and then press the ● key to confirm.

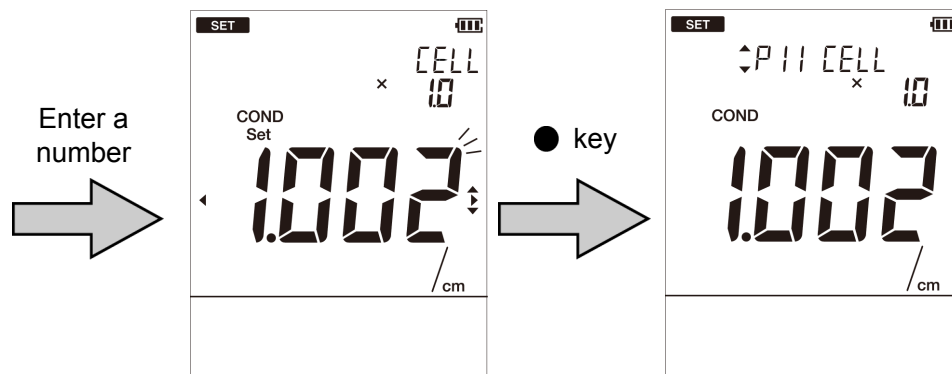







To return to the measurement mode, press the ↻ key.

**Note**

- The unit used for the cell constant corresponds to the unit set in "Setting the conductivity unit (default: S/cm)" (page 43).
  - When the cell constant is changed through the cell constant setting, all the previous calibration data is deleted.
  - Match the unit indicated on the conductivity cell to the unit set in the instrument.  
 $10 \text{ m}^{-1} \Leftrightarrow 0.1 \text{ cm}^{-1}$      $100 \text{ m}^{-1} \Leftrightarrow 1 \text{ cm}^{-1}$      $1000 \text{ m}^{-1} \Leftrightarrow 10 \text{ cm}^{-1}$
-

• **Setting the temperature conversion (Default: ON, 2.00%/°C)** (ALL)

The measured value of a sample that is not at 25°C can be converted to a value at the selected temperature. To use the temperature conversion function correctly, temperature coefficient (the rate of change per 1°C of the conductivity) must be set for each sample. The setting of "Setting the temperature display" (page 41) is applied to the sample temperature before the conversion.

1. Press the  key to enter the setting mode.
2. Press the   keys to select "COND" (conductivity setting) and then press the  key.
3. Press the   keys to select "TEMP CF" (temperature conversion setting) and then press the  key.

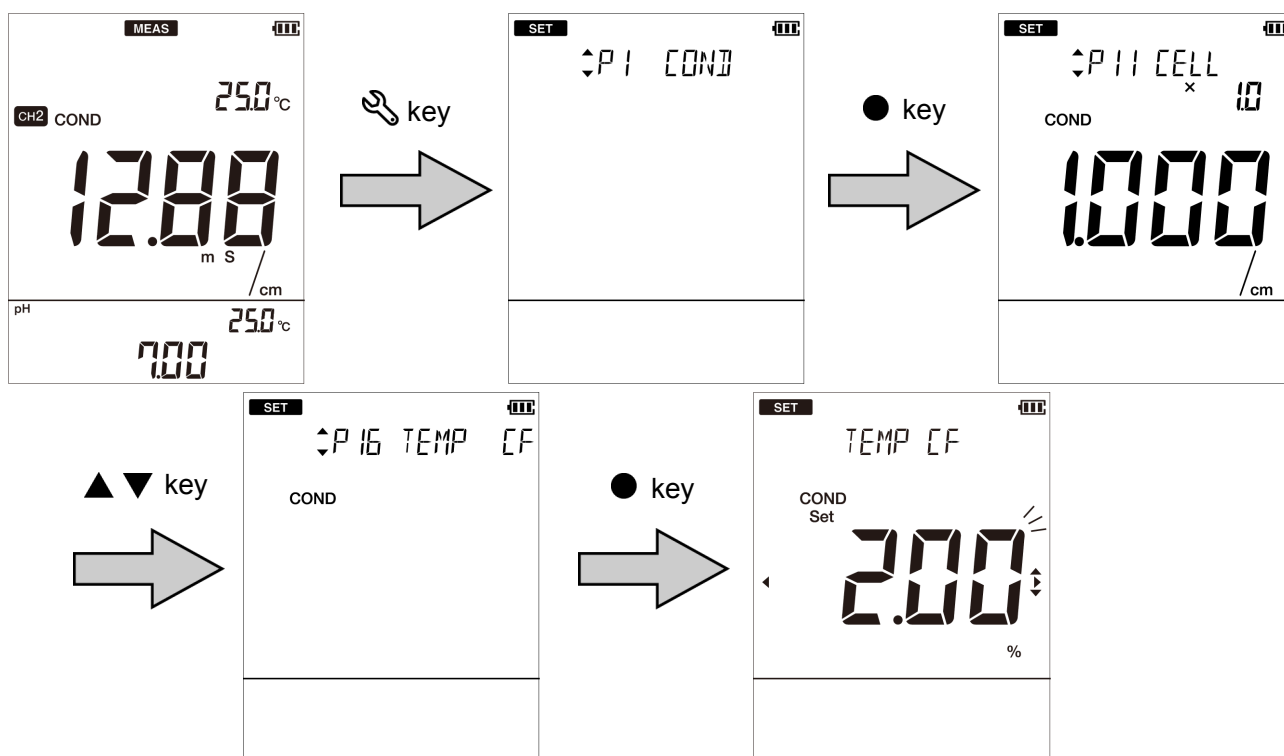

4. Press the     keys to enter the temperature coefficient and then press the  key to confirm.

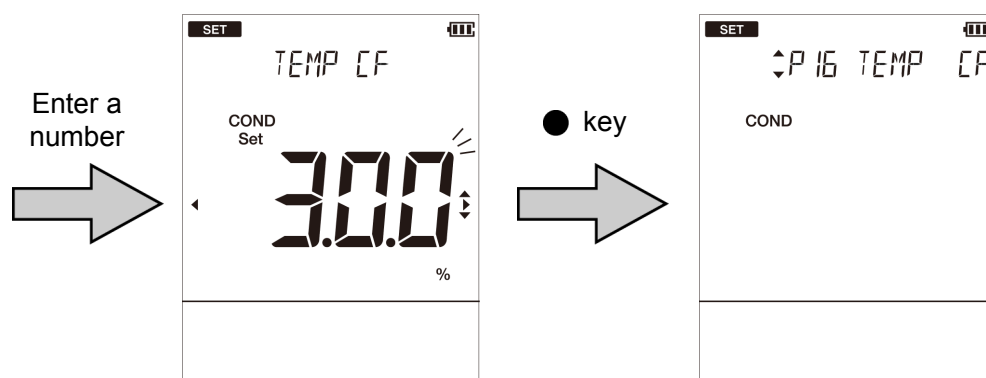







To return to the measurement mode, press the  key.

### Note

- The temperature coefficient varies by sample. Before using the temperature conversion function, always check the temperature coefficient of the sample and set it in the instrument.
  - When the temperature conversion function is used with automatic temperature measurement (ATC), deviations may occur within the accuracy of the temperature sensor. For more accurate measurement, set the temperature setting to manual temperature display (MTC), and measure using a temperature controlled bath.
-

• **Setting the reference temperature (Default: 25°C) (COND)**

Temperature to be converted can be selected from 15°C to 30°C.

1. Press the  key to enter the setting mode.
2. Press the   keys to select "COND" (conductivity setting) and then press the  key.
3. Press the   keys to select "TEMP REF" (reference temperature setting) and then press the  key.

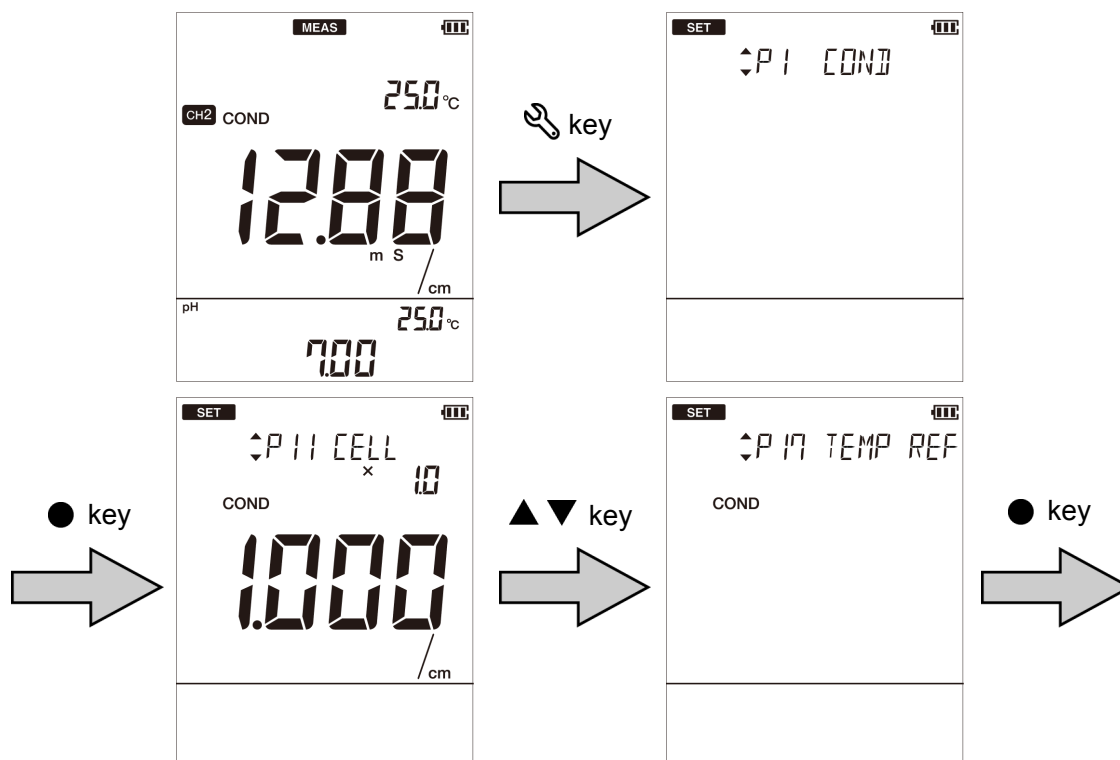

4. Press the     keys to enter the reference temperature and then press the  key to confirm.

Temperature can be selected from 15°C to 30°C.

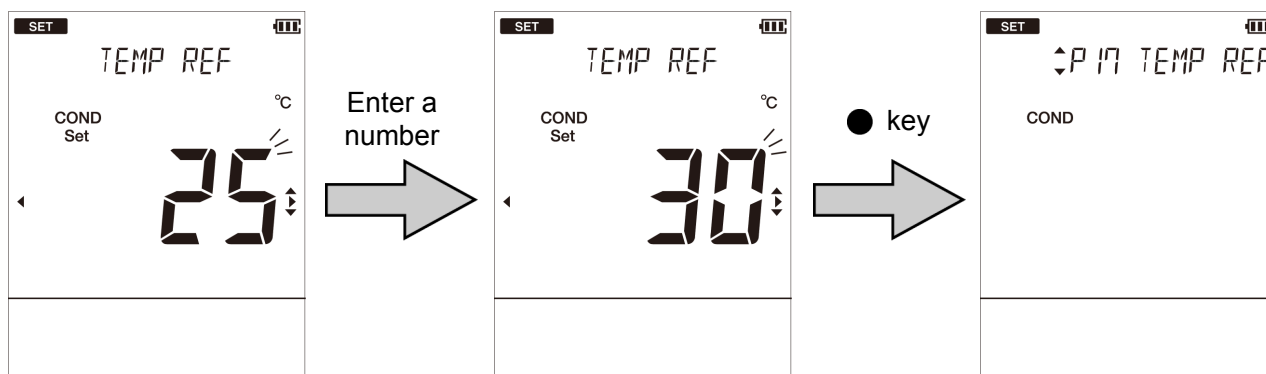







To return to the measurement mode, press the  key.



• **Setting the TDS method** TDS

TDS is calculated from the measured conductivity value. The available calibration methods are "LINEAR": KCl with factor adjustable from 0.4 to 1.0 (default: 0.5), "442": Myron L 442 non-linear standard curve, "EN27888": European environmental standard non-linear curve, and "NACL": non-linear salinity curve.

1. Press the  key to enter the setting mode.
2. Press the   keys to select "TDS" (total dissolved solid setting) and then press the  key.
3. Press the   keys to select "TDS TYPE" (TDS method setting) and then press the  key.

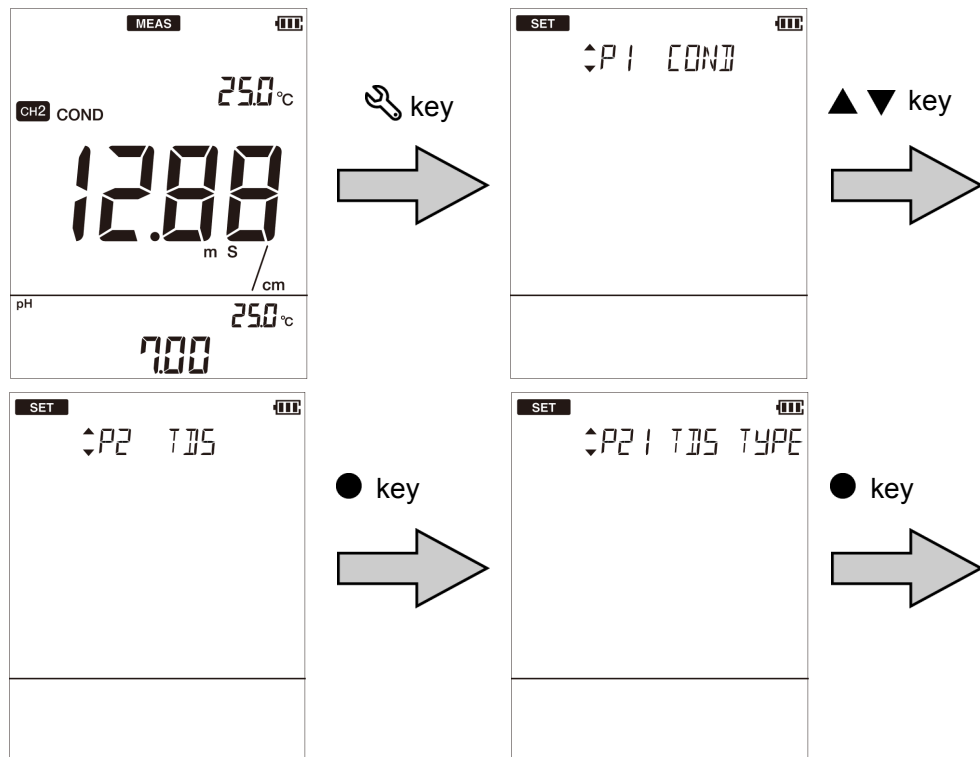



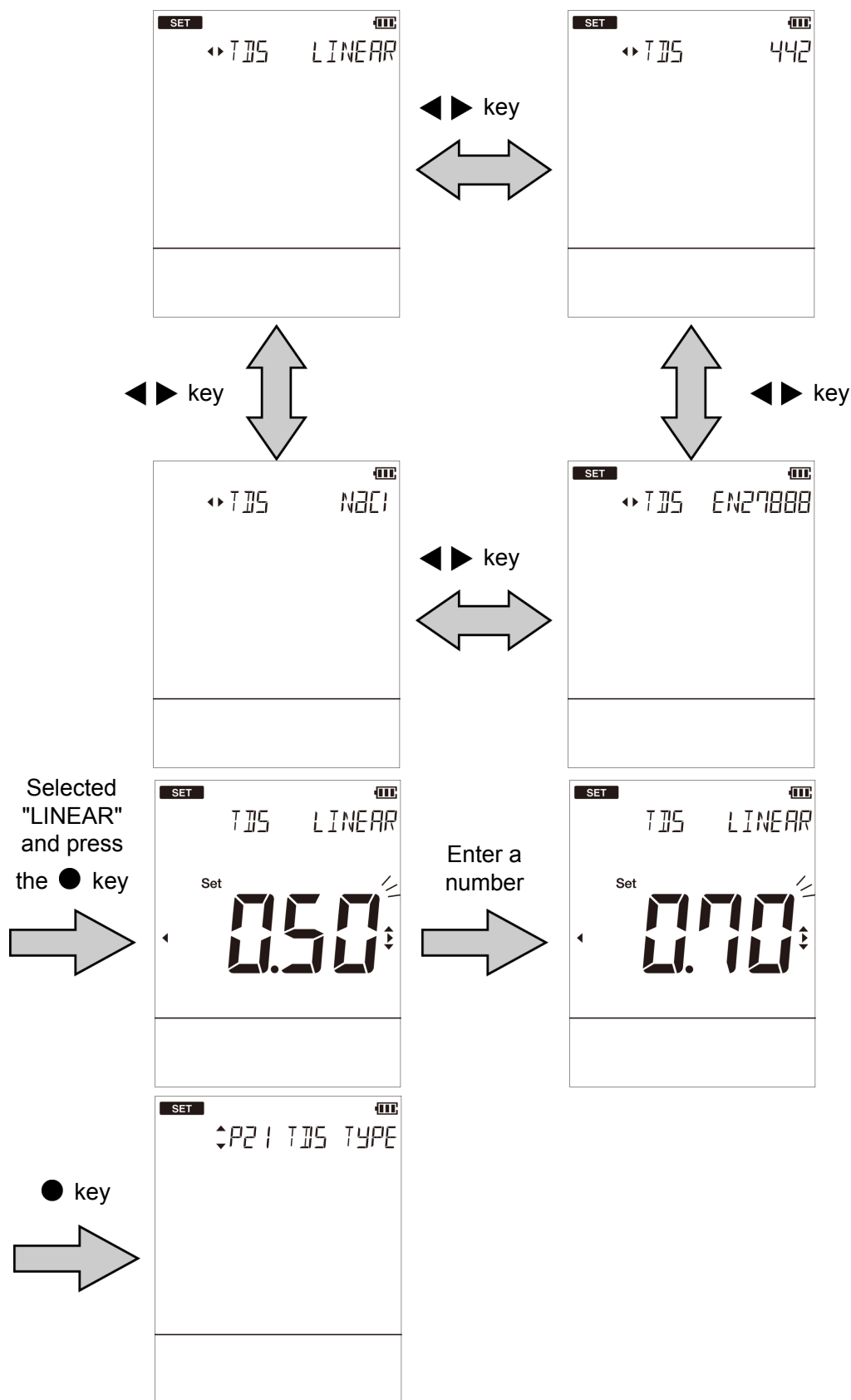



4. Press the ◀▶ keys to select the TDS method and then press the ● key.
5. When selecting "LINEAR", enter the factor and then press the ● key to confirm.



To return to the measurement mode, press the  key.

• **Setting the salinity method** (SAL)

Salinity is calculated from the measured conductivity value. The available calibration methods are "NACL" and "SEAWTR" (sea water).

1. Press the  key to enter the setting mode.
2. Press the   keys to select "SALT" (salinity setting) and then press the  key.
3. Press the   keys to select "SALT TYP" (salinity calculation method setting) and then press the  key.

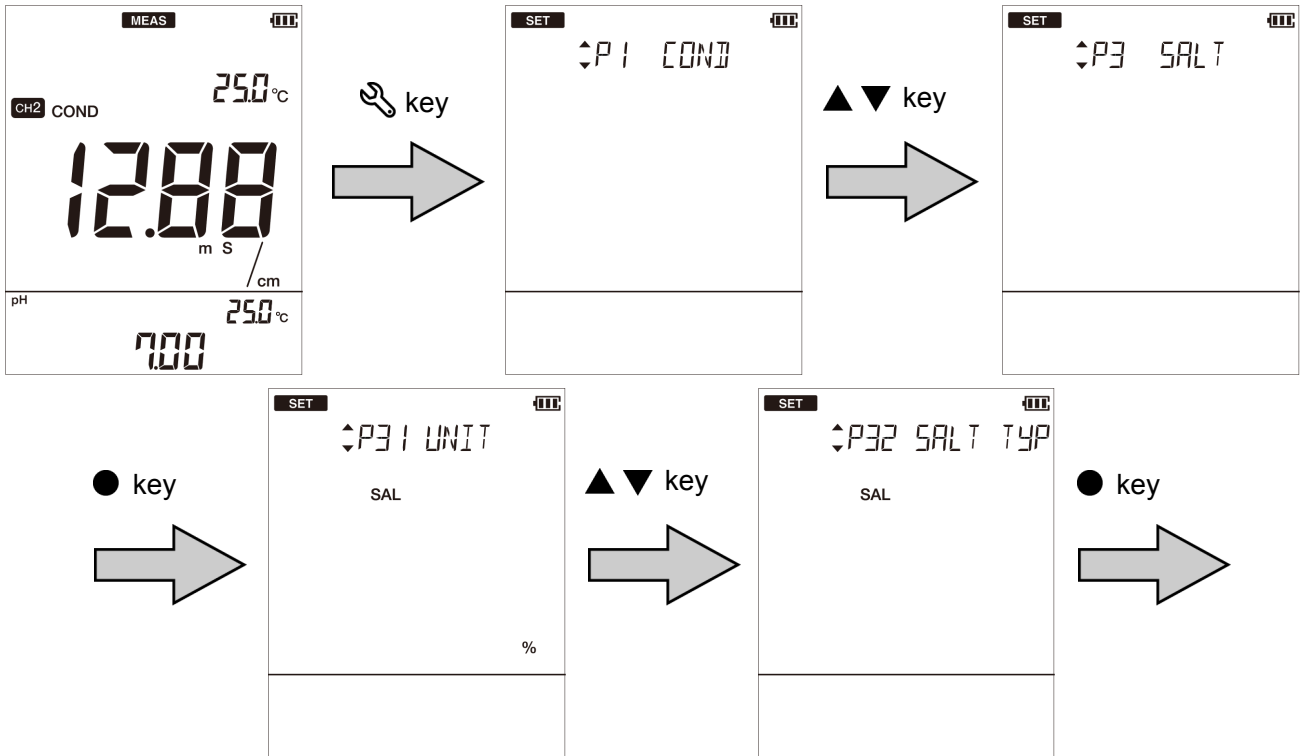

4. Press the ◀▶ keys to select the salinity calculation method and then press the ● key to confirm.

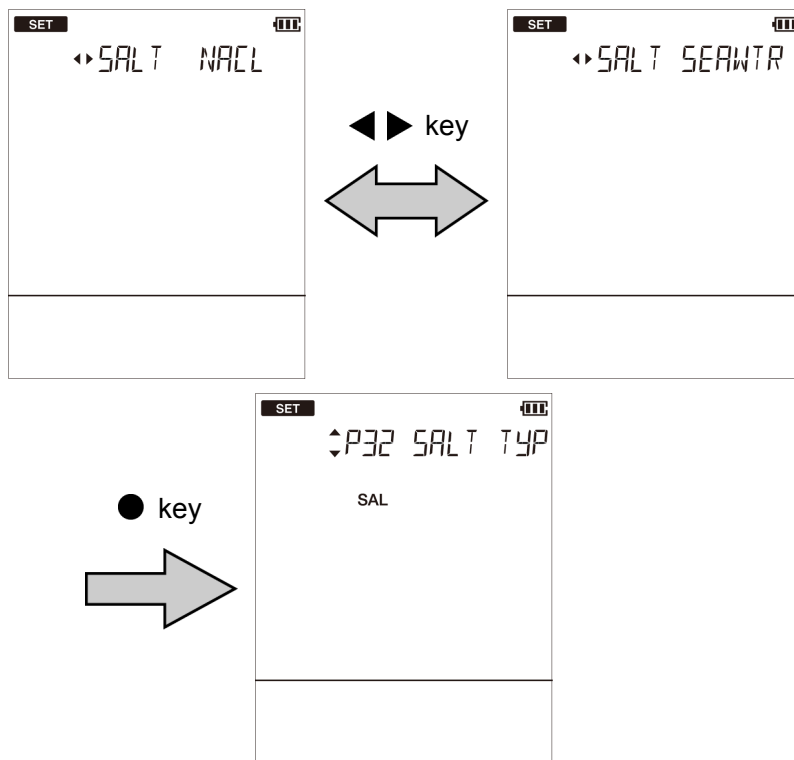

To return to the measurement mode, press the ↻ key.

## ● Performing conductivity calibration

The factory-certified cell constant is indicated on the label on the electrical conductivity cell. Cell constant may change depending on the usage condition. In such case, the conductivity cell can be calibrated automatically or manually.

You can select calibration method. For how to set the mode, refer to "Changing the calibration method" (page 73).

### •Automatic calibration

1. **Clean the conductivity cell with pure water (or deionized water) and wipe it with filter paper or tissue paper.**

Do not touch the black electrode part.

Refer to the instruction manual of the conductivity cell for how to clean the conductivity cell.

2. **Immerse the conductivity cell in the standard solution.**

Make sure the hole at the upper part of the cell is immersed.

3. **Press the  key to enter the calibration mode.**

Stability judgment starts and the COND icon blinks. When the measured value stabilizes, the COND icon changes from the blinking state to the lit state.

4. **Press the  key or the  key.**

The 1st point calibration ends and the calibration history icon corresponding to the calibration range lights, indicating that 1st point calibration is complete.

The display returns to the measurement screen.

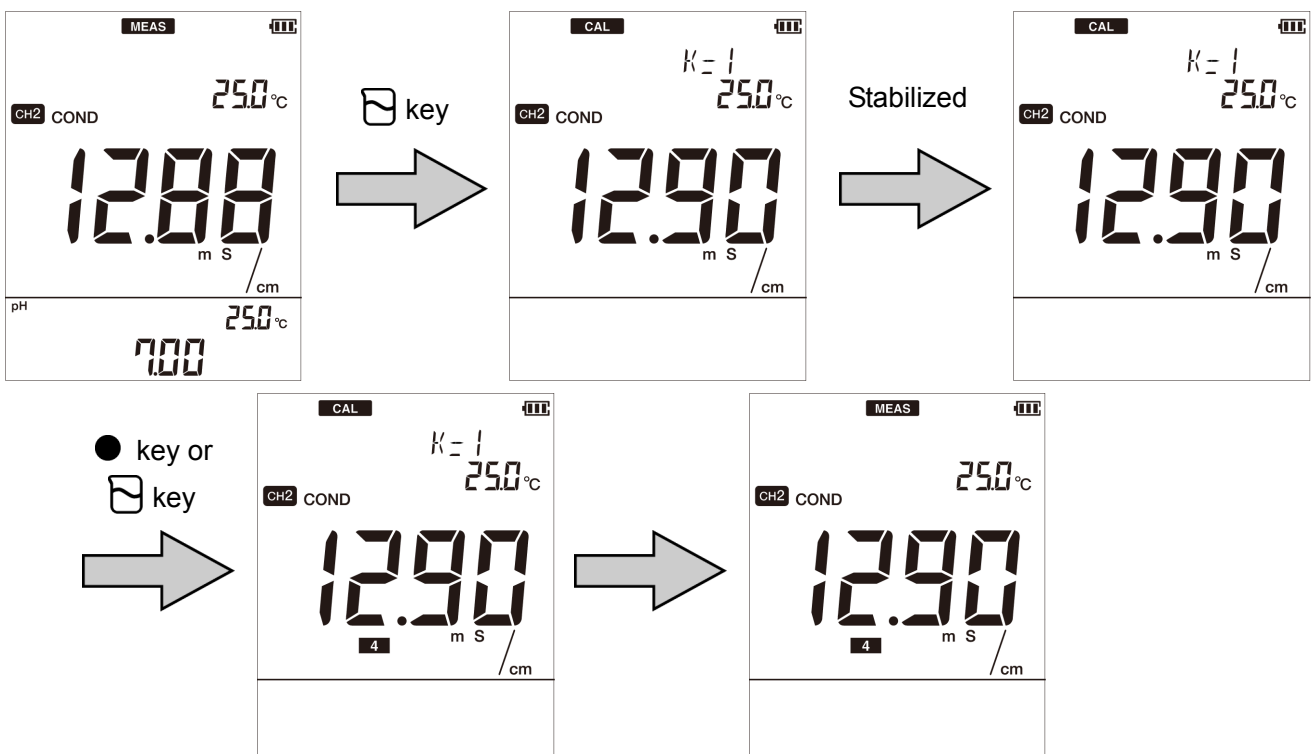
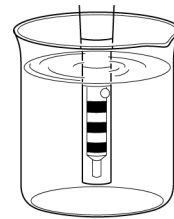
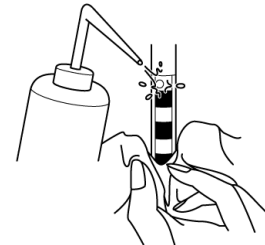

For multiple point calibration, repeat the steps 1. to 4.

## Conductivity measurement

---

### Note

In automatic calibration, the measured value of a standard solution that is not at 25°C is always converted to 25°C with 2.00%/°C temperature coefficient.

---

**•Manual calibration**

1. **Clean the conductivity cell with pure water (or deionized water) and wipe it with filter paper or tissue paper.**

Do not touch the black electrode part.





Refer to the instruction manual of the conductivity cell for how to clean the conductivity cell.

2. **Immerse the conductivity cell in the standard solution.**

Make sure the hole at the upper part of the cell is immersed.

3. **Press the  key to enter the calibration mode.**

Stability judgment starts and the COND icon blinks. When the measured value stabilizes, the COND icon changes from the blinking state to the lit state.

4. **Press the     keys to enter the electrical conductivity value of the standard solution used for calibration at the measured temperature.**

5. **Press the  key or the  key.**

Calibration to the set standard solution value at the measured temperature is performed. The 1st point calibration ends and the calibration history icon corresponding to the calibration range lights, indicating that 1st point calibration is complete.

The display returns to the measurement screen.

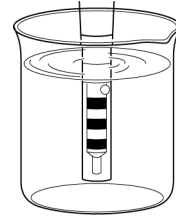
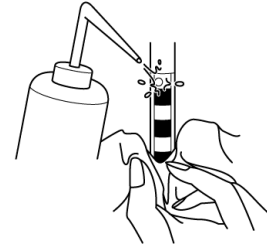

## Conductivity measurement

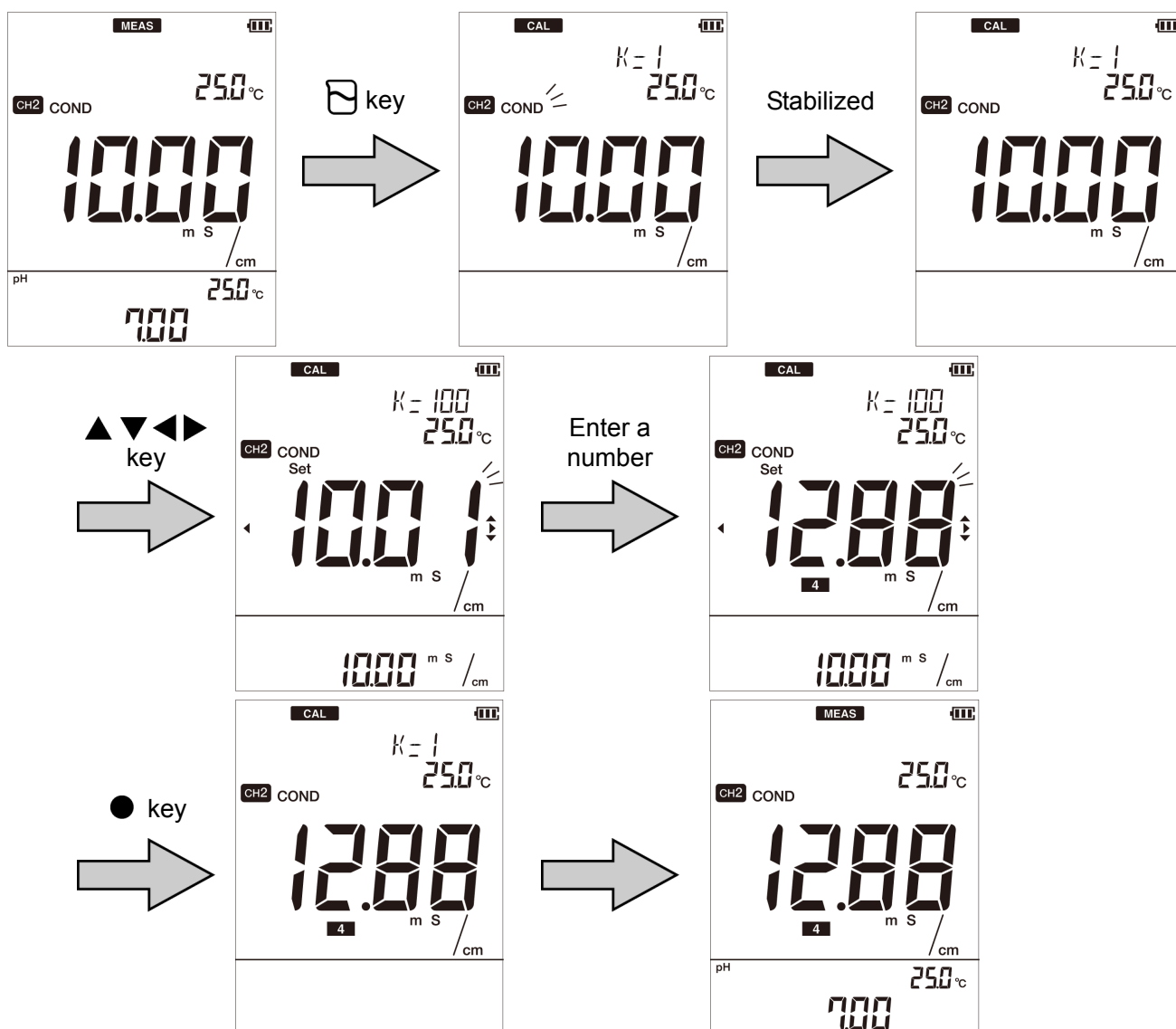

For multiple point calibration, repeat the steps 1. to 5.  
The calibration points are up to 5 points.

### Note

The calibration for TDS, salinity, and resistivity is performed with the result of the calibration of conductivity. When pressing the  key to enter the calibration mode for TDS, salinity, and resistivity, "CAL in COND" is displayed. It indicates that performing conductivity calibration is recommended.



## ● Performing measurement ALL

Immerse the conductivity cell in a sample to perform measurement. Auto stability mode and auto hold mode are available to judge the stability of the measurement value. For details of settings, refer to "Setting the auto stability and auto hold function" (page 79).

1. Press the  key to change to the measurement parameter to measure.
2. Clean the conductivity cell with pure water (or deionized water) and wipe it with filter paper or tissue paper.

Do not touch the black electrode part.

Refer to the instruction manual of the conductivity cell for how to clean the conductivity cell.

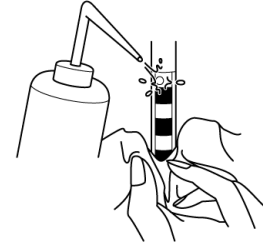

3. Immerse the conductivity cell in the sample solution.

Make sure the hole at the upper part of the cell is immersed.

Stability judgment starts and the measurement item icon blinks. When the measured value stabilizes, the measurement item icon changes from the blinking state to the lit state, and the display is fixed to the stabilized measured value.

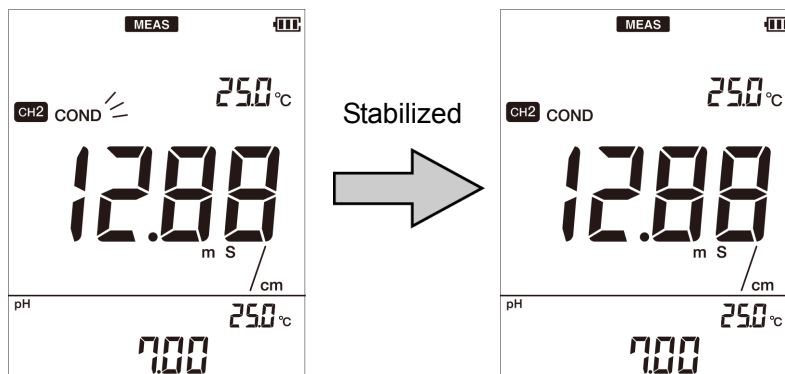
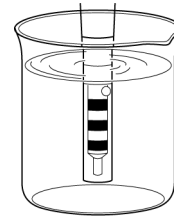

### Note

- The criteria of stability judgment in the auto stability mode and auto hold mode are as follows.
  - Conductivity: Display value change for 10 seconds is less than 3 digit and temperature change is less than 2.0°C.
  - Salinity: Display value change for 10 seconds is less than 1.0 PPT (0.1%) and temperature change is less than 2.0°C.
  - TDS: Display value change for 10 seconds is less than 30 mg/L and temperature change is less than 2.0°C.
  - Resistivity: Display value change for 10 seconds is less than 3 digit and temperature change is less than 2.0°C.
- If the measured value is above the display range, "Or" (over) appears. For details on the action to take, refer to "The measured value is out of the measurement range" (page 107).

### ● Saving measured values

To save the measurement data, press the ● key in the screen that you want to save. For details, refer to "Saving measurement data in the internal memory" (page 16).

# Using Various Functions





This section describes functions available in this instrument.





■ <b>Data functions</b> .....	<b>64</b>
● Displaying saved data.....	64
● Using the automatic data save.....	65
● Deleting all saved data.....	68
■ <b>Measurement setting</b> .....	<b>70</b>
● Displaying the latest calibration and inspection data .....	70
● Changing the calibration method .....	73
● Using the calibration interval alarm (default: OFF).....	74
● Deleting calibration data.....	75
■ <b>Temperature settings</b> .....	<b>77</b>
● Calibrating temperature sensor .....	77
■ <b>General settings</b> .....	<b>79</b>
● Setting the auto stability and auto hold function.....	79
● Changing the automatic power off setting (default: 30 min).....	81
● Resetting to factory default settings .....	83
● Setting the date and time.....	85
● Performing test printing of the printer unit.....	87
■ <b>Other settings</b> .....	<b>89</b>
● Printing measured values and calibration data.....	89
● Transferring saved data to a PC .....	93
● Operating the instrument from an external device .....	94

## ■ Data functions

### ● Displaying saved data

You can display the data saved in the internal memory.

1. Press the  key to enter the data mode.
2. Press the   keys to select "DATA OUT" (display saved data) and then press the  key.

Press the   keys to change the measurement data and press the   keys to change the display between date and data number.

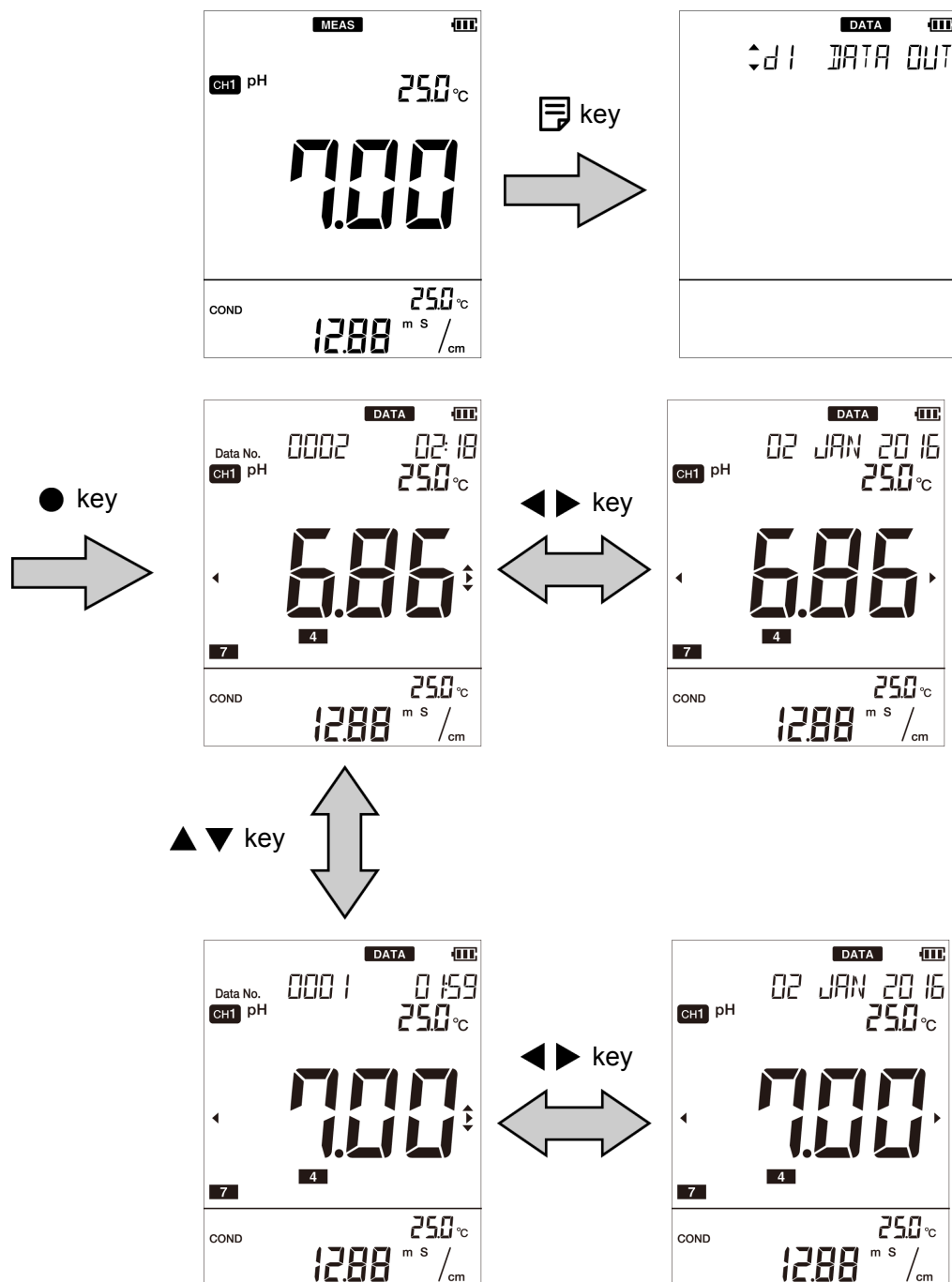

To return to the measurement mode, press the  key and then press the  key.

## ● Using the automatic data save

This function saves the data in the internal memory of the instrument at the specified interval automatically.

While using this function, auto stability and hold mode are not available and the automatic power off setting is disabled.

If the batteries run out while using the automatic data save function, the data saved until just before the batteries run out. Replace the batteries and check the data.

1. Press the  key to enter the setting mode.
2. Press the   keys to select "AUT LOG" (automatic data save) and then press the  key.

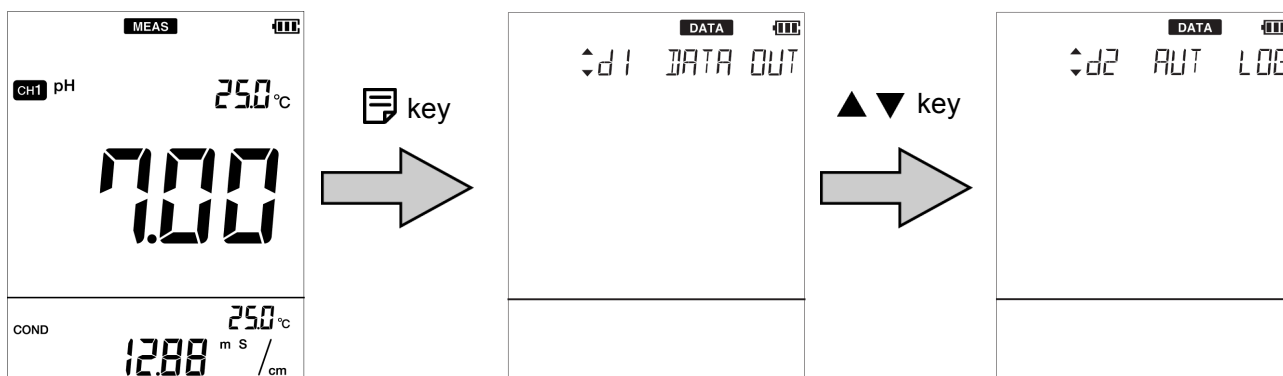

3. **Enter the interval of saving in seconds and press the ● key.**  
 An interval from 0, 2 s to 3600 s can be set.  
 When "0" is entered, this function is set to OFF.
4. **Enter the period of saving in minutes and press the ● key.**  
 A period from 0 min to 3600 min can be set.  
 "0" indicates no period.

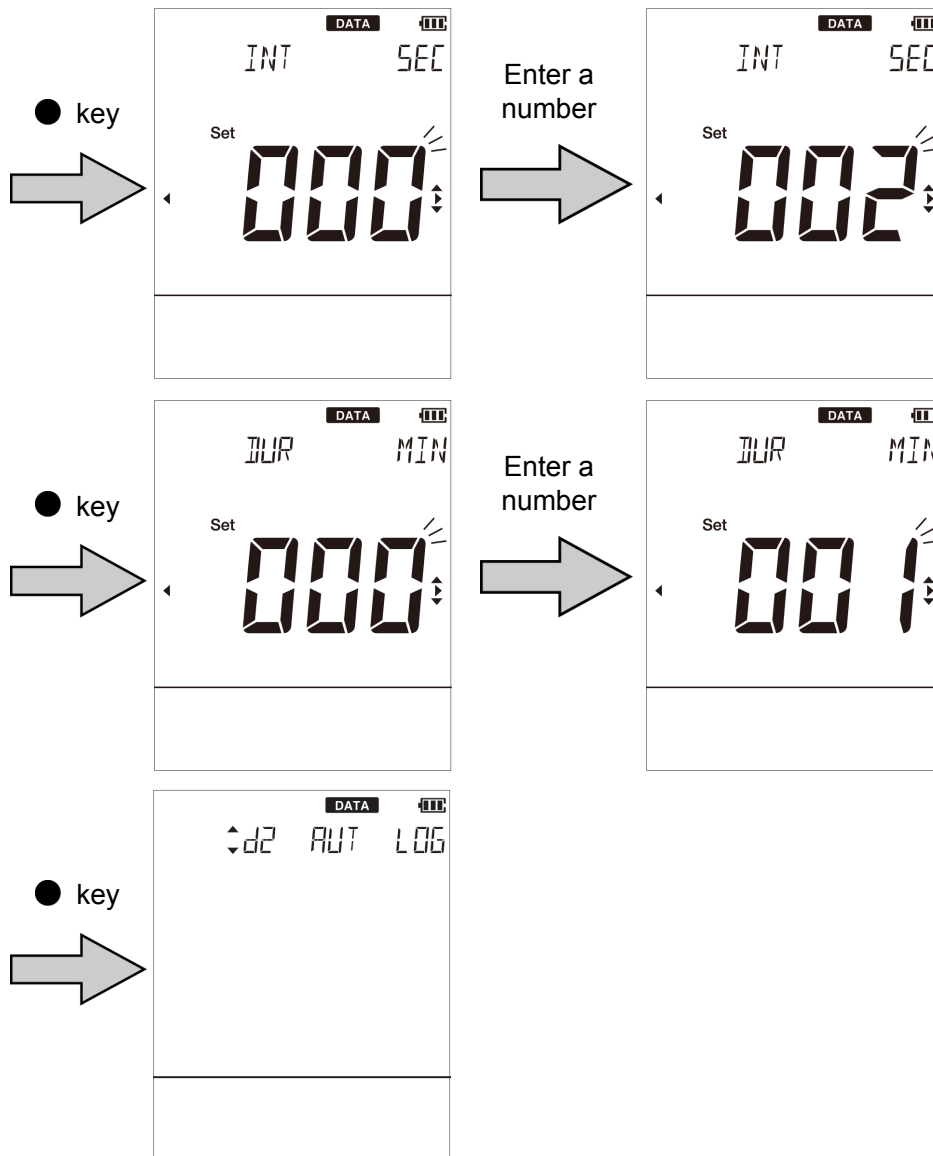

5. **Press the  key to return the measurement mode.**

**6. Pressing the ● key starts saving the data (when the setting is "ON").**

Pressing the ● key again stops the data saving process. During automatic data saving measurement, data is displayed for one second each time a measurement takes place. When more than 1000 data items are saved, "ERR No. 0010" is displayed and data saving is stopped. When you delete the data, the error is cleared (refer to "Deleting all saved data" (page 68)).

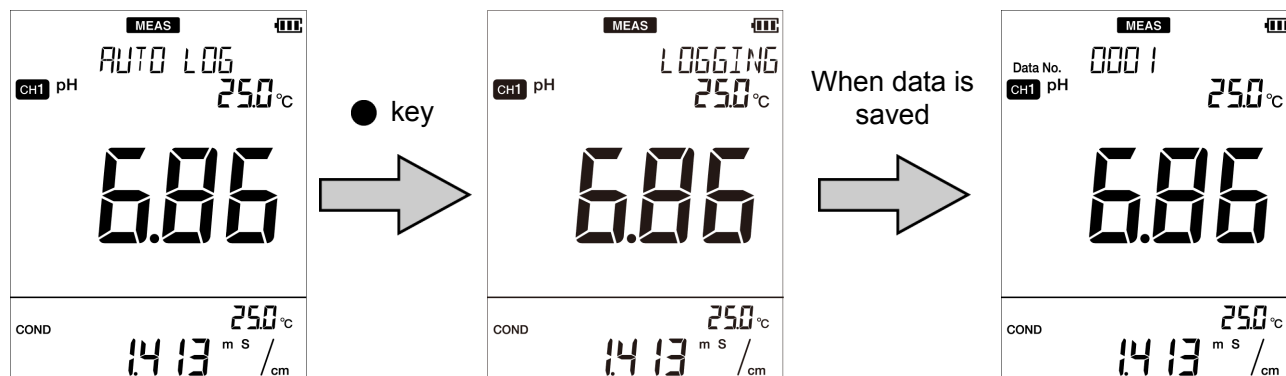

## ● Deleting all saved data

Delete all data saved in the internal memory. Data cannot be deleted selectively. Copy or transfer the data to a PC for storage if necessary.

1. Press the  key to enter the data mode.

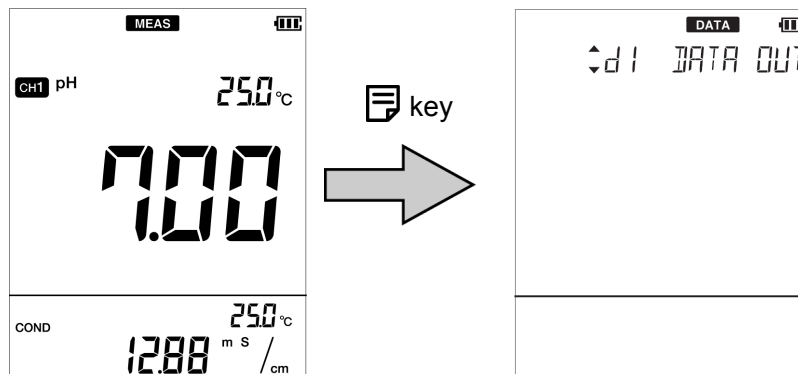

2. Press the ▲ ▼ keys to select "DATA CLR" (delete saved data) and then press the ● key to confirm.



3. Select "YES" to delete the saved data, or select "NO" to cancel deleting it. And then press the ● key to confirm.

When "YES" is selected, "END" appears after deletion is complete.

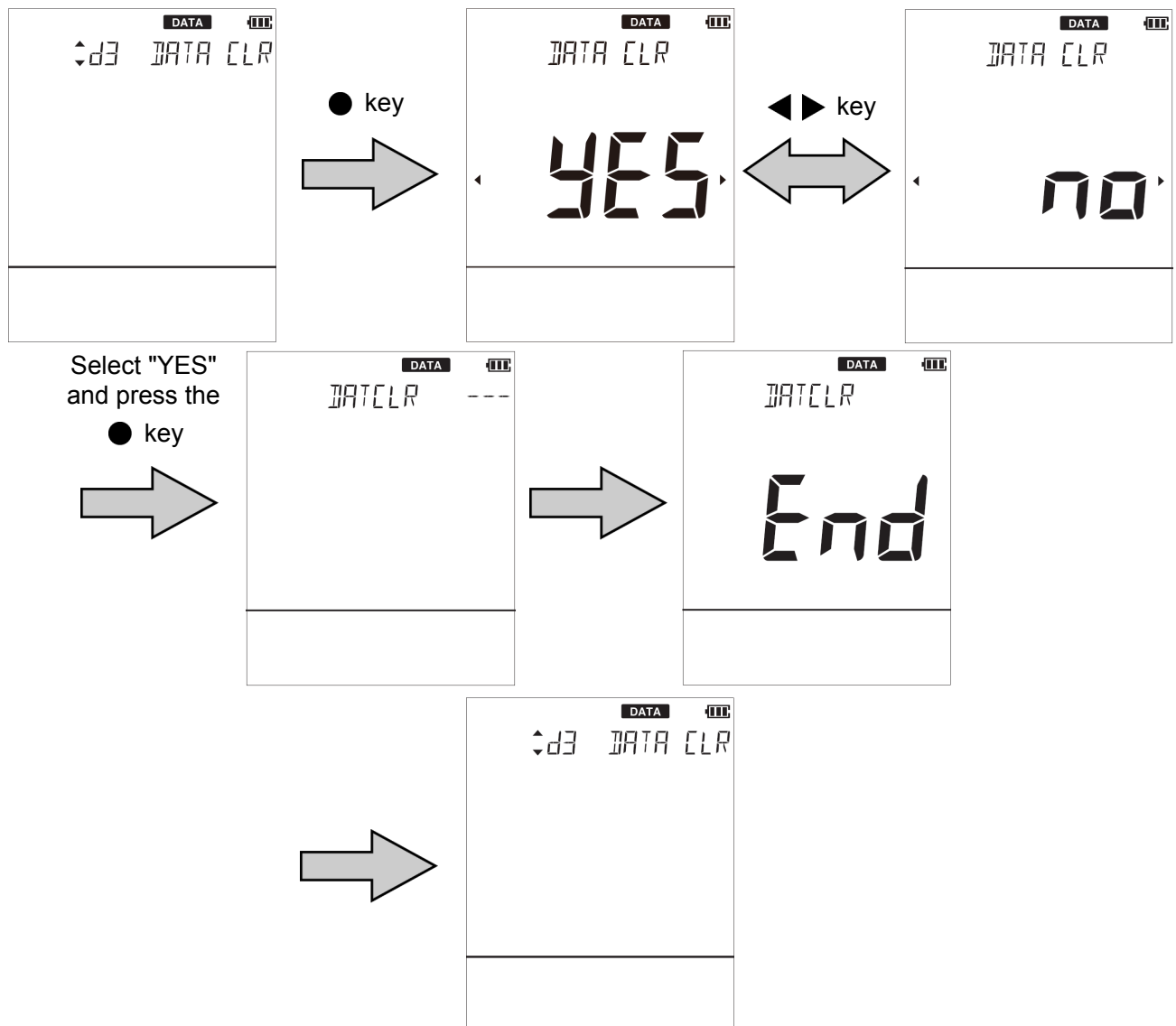





To return to the measurement mode, press the  key.

## ■ Measurement setting

### ● Displaying the latest calibration and inspection data

You can display the latest calibration data and repeatability inspection data.

#### • In the case of displaying the latest pH calibration data and repeatability inspection data

1. Press the  key to enter the data mode when "pH" icon is shown on the main screen.
2. Press the   keys to select "pH" and then press the  key.

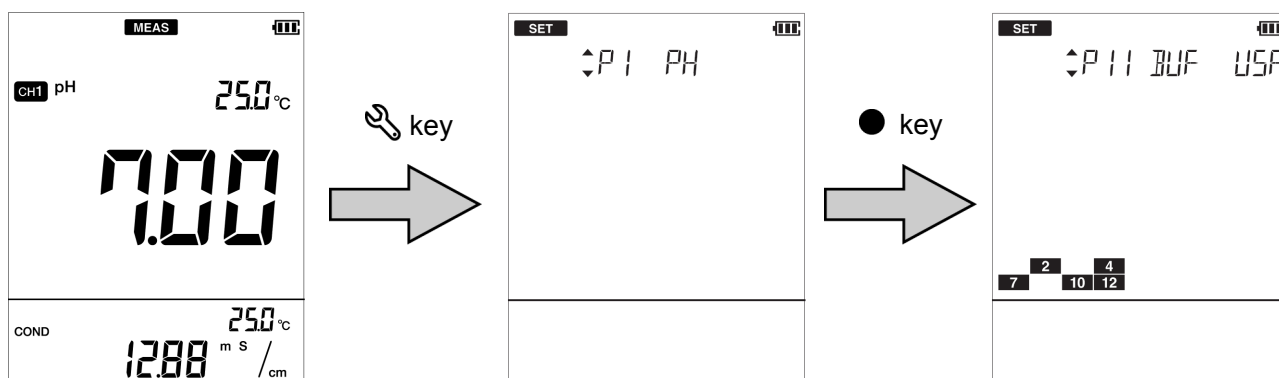

3. Press the ▲▼ keys to select "CAL DATA" (display calibration data) and then press the ● key.

The electrode status based on the calibration result is displayed. You can change the display item among "OFS" (asymmetry potential) to SLP (sensitivity) to REP (repeatability) by pressing the ◀▶ keys.

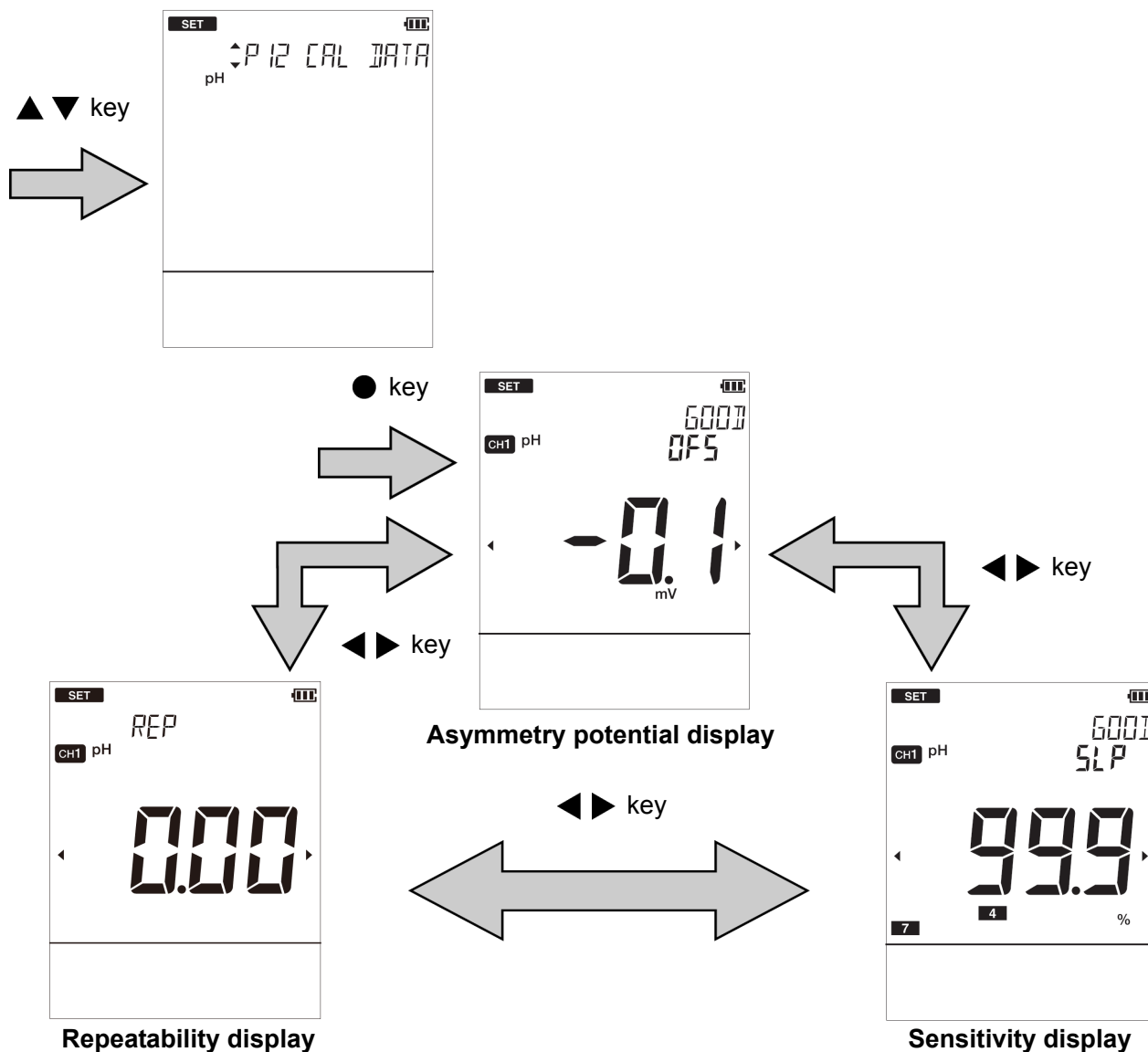

To return to the measurement mode, press the key and then press the key.







Tip



- The asymmetry potential can be displayed only for pH calibration data.
- When multiple point calibration (more than two points) is performed, the results of multiple point calibration are displayed.

- Electrode status based on calibration result

Display	Description	Reference
GOOD	Electrode sensitivity: 85% to 105% Good condition.	—

• In the case of displaying the latest conductivity calibration data

1. Press the  key to enter the setting mode when "COND" icon is shown on the main screen.
2. Press the   keys to select "COND" (conductivity setting) and then press the  key.
3. Press the   keys to select "CAL DATA" (display calibration data) and then press the  key.



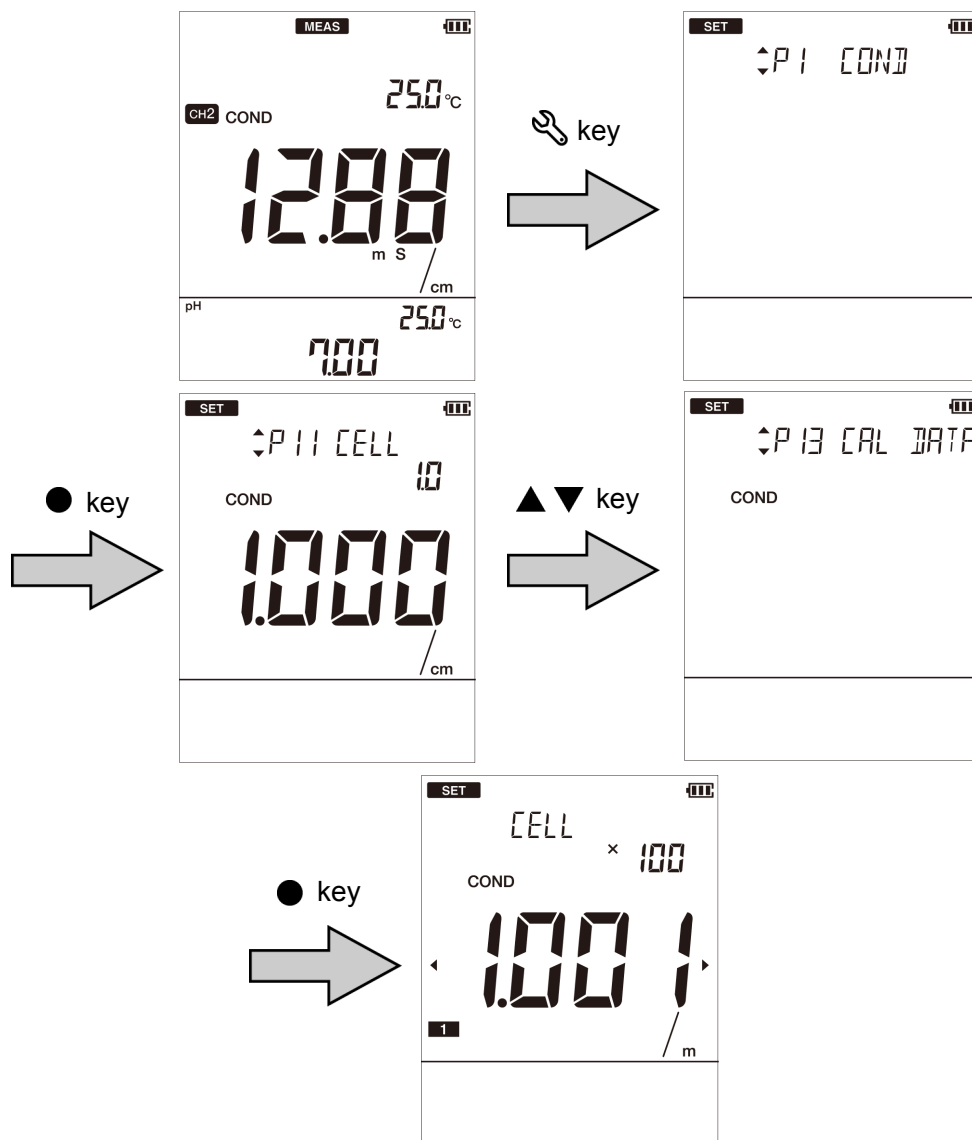





The cell constants determined by calibration are displayed. Press the   key to show the cell constants in order of ranges.



To return to the measurement mode, press the  key and then press the  key.

## ● Changing the calibration method

Select automatic calibration or manual calibration for the conductivity calibration method.

1. Press the  key to enter the setting mode when "COND" icon is shown on the main screen.
2. Press the   keys to select "COND" (conductivity setting) and then press the  key.
3. Press the   keys to select "AUTO CAL" (automatic calibration setting) and then press the  key.
4. Select "ON" to set the automatic calibration, or select "OFF" to set the manual calibration. And then press the  key to confirm.

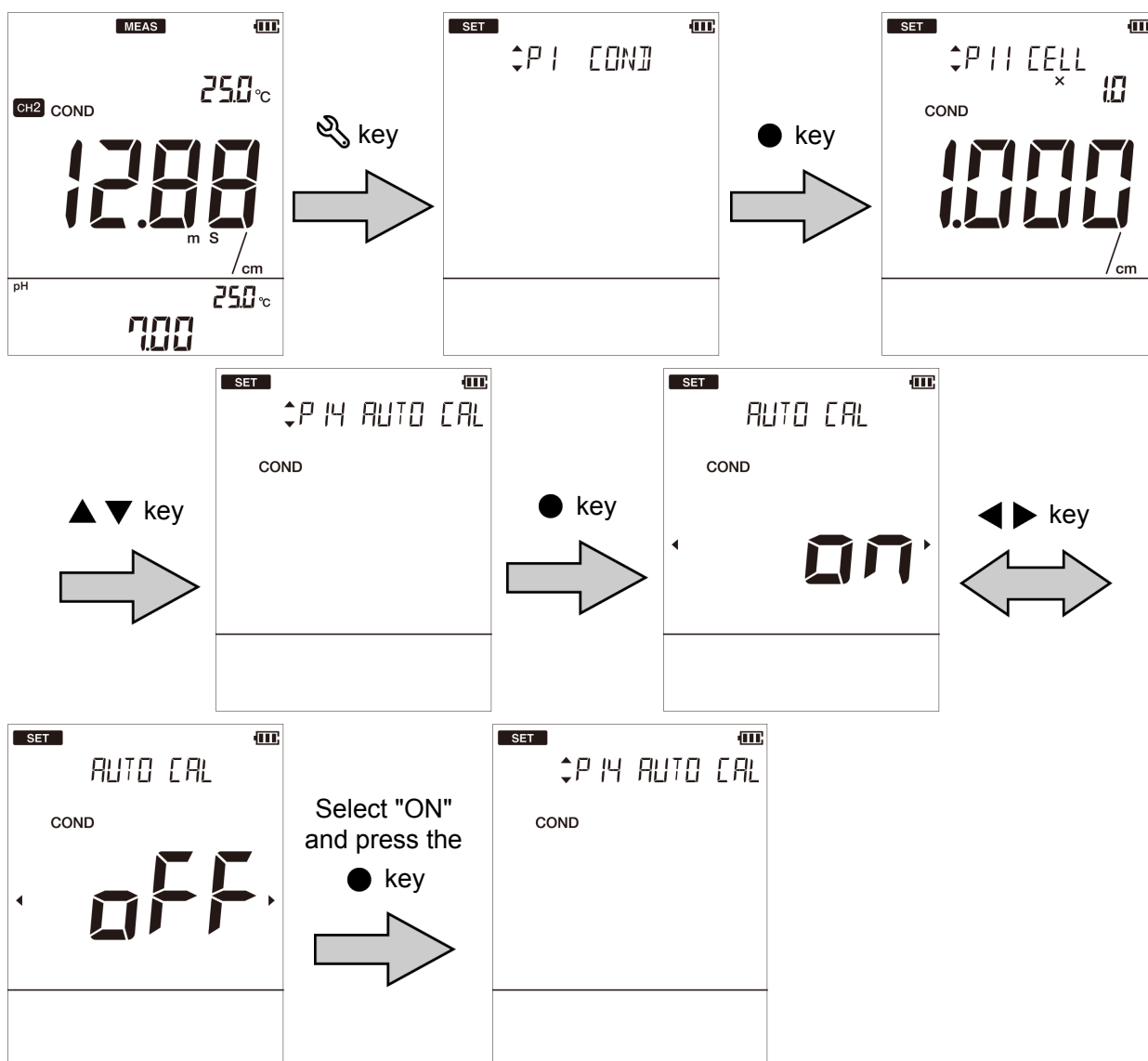







To return to the measurement mode, press the  key.

### Note

When the setting of calibration method (auto or manual) is changed, the cell constant is initialized. Make sure to enter the cell constant or to perform calibration again.

## ● Using the calibration interval alarm (default: OFF)

If calibration has not been performed for set period of time after last calibration is performed, "ERR No. 0008" is displayed to prevent forgetting to perform calibration. When the error is displayed, performing calibration clears the error.

1. Press the  key to enter the setting mode when "pH" icon is shown on the main screen.
2. Press the   keys to select "pH" (pH setting) and then press the  key.
3. Press the   key to select "CAL ALR" (calibration alarm setting) and then press the  key.

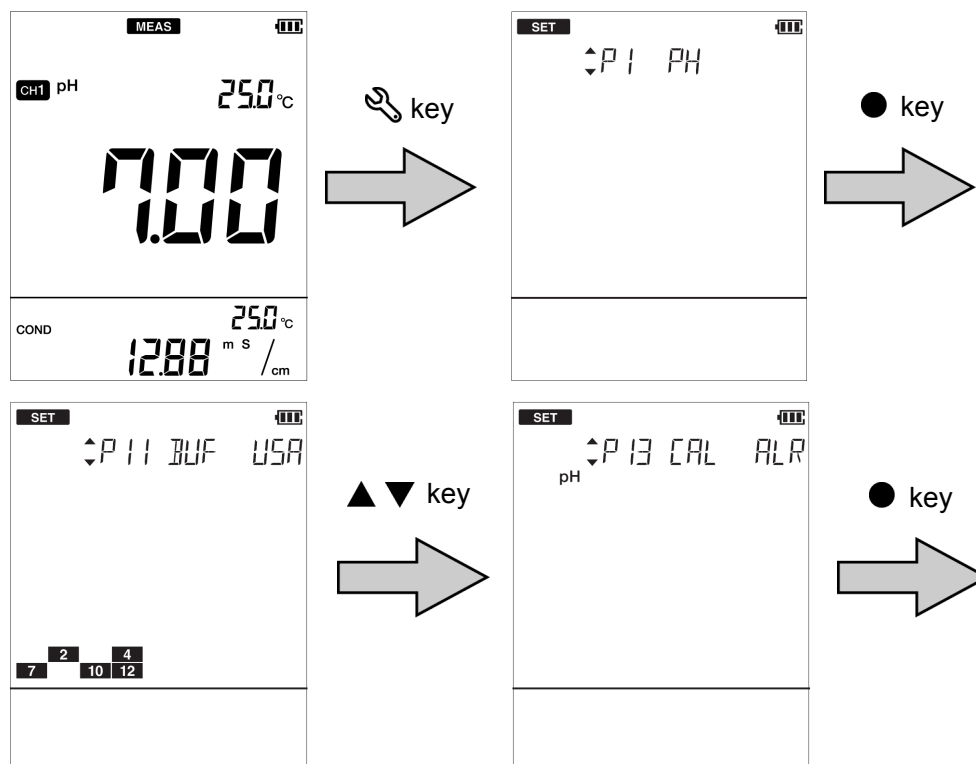

4. Enter the setting period of the calibration interval alarm and then press the  key.



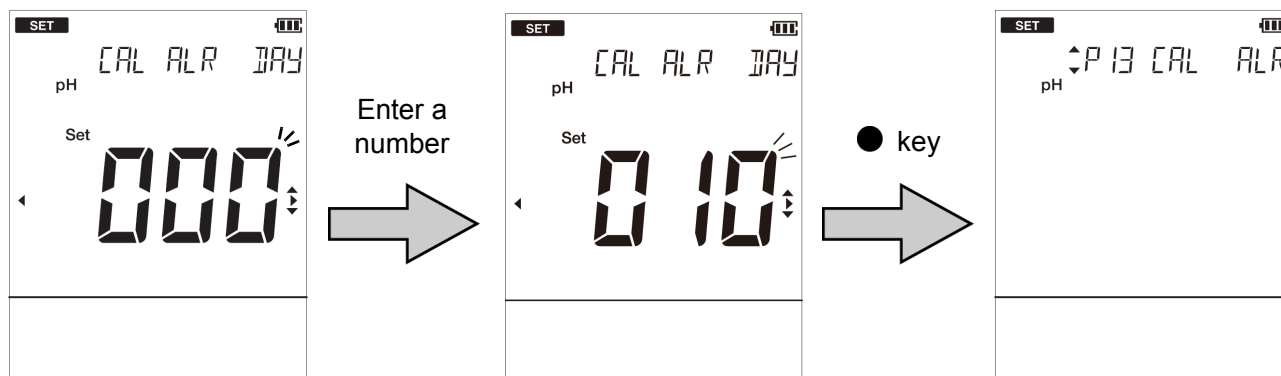

The setting range is 1 day to 400 days.



To return to the measurement mode, press the  key.

## ● Deleting calibration data

Delete the calibration data set in the instrument.

1. Press the  key to enter the setting mode.
2. Press the  key to select the component to delete the data from "pH" or "COND" and then press the  key.
3. Press the  keys to select "CAL CLR" (delete calibration data) and then press the  key.

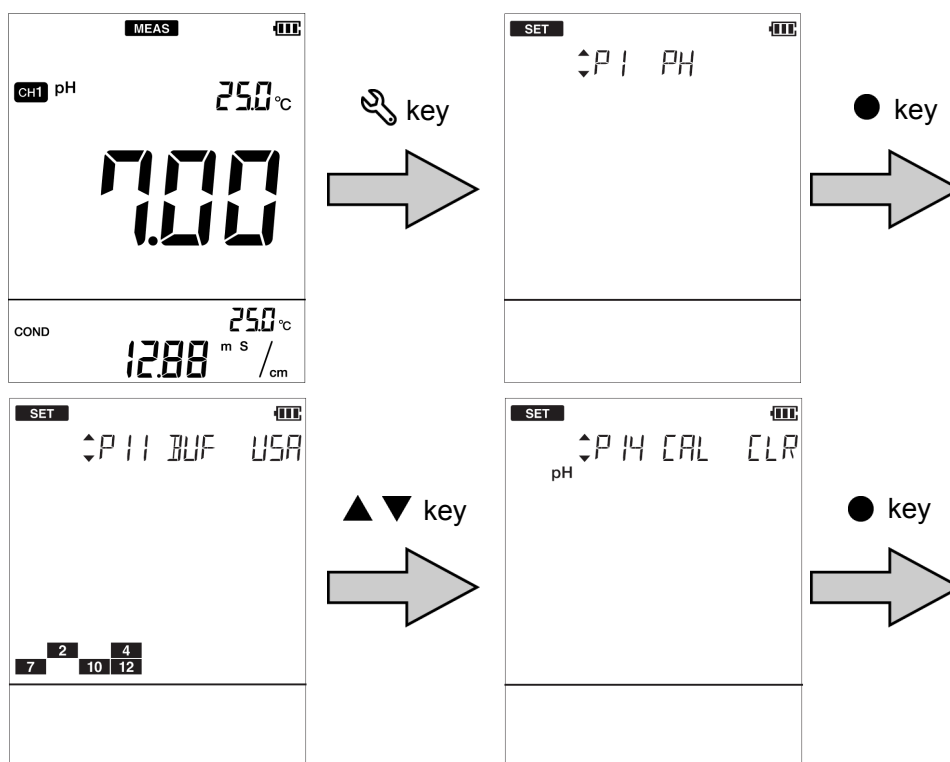

(Ex.: "pH" is selected)

4. Select "YES" to delete the calibration data, or select "NO" to cancel deleting it. And then press the ● key to confirm selection.

When "YES" is selected and ● is pressed, "END" appears after deletion is complete.

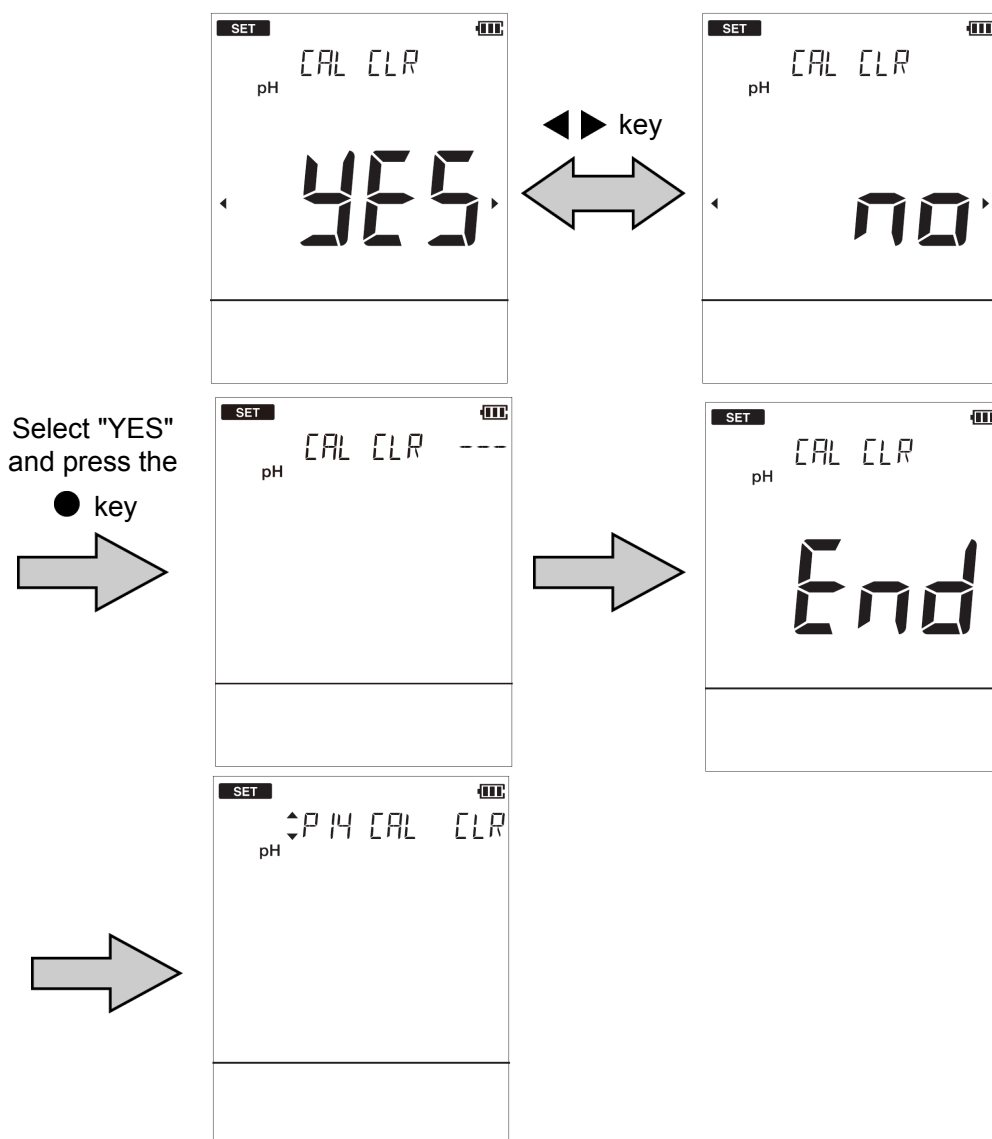

To return to the measurement mode, press the  key.

Tip





When the  key is pressed for more than three seconds in the measurement mode, "CALCLR" screen appears, and the calibration data can be deleted.





## ■ Temperature settings

### ● Calibrating temperature sensor

The temperature sensor or temperature compensation electrode in the combination electrode has  $\pm 1^{\circ}\text{C}$  accuracy without calibration. You can use a known temperature solution to calibrate the temperature sensor.

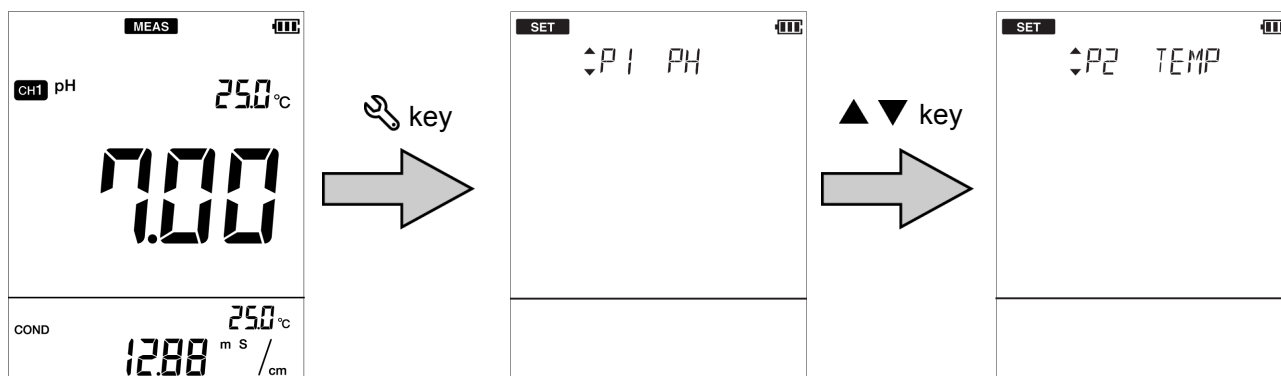
1. Insert the temperature connector into the jack of temperature connector (T) on the instrument.
2. Immerse the electrode into the solution until the temperature sensor is immersed.
3. Press the  key to enter the setting mode when the channel which is connected to the temperature sensor to calibrate is active.
4. Press the   keys to select "TEMP" (temperature calibration setting) and then press the  key.



5. Make sure that "ATC" is displayed, and press the  key. The temperature setting screen is displayed.
6. Enter the set temperature and press the  key to confirm. The temperature sensor is calibrated.

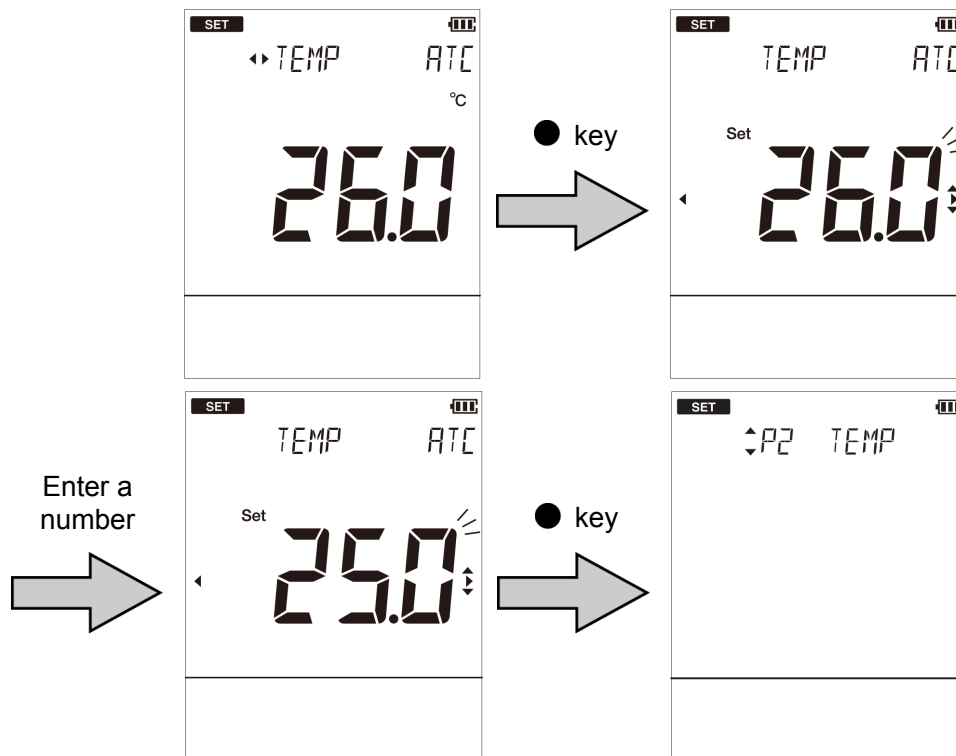

To return to the measurement mode, press the  key.

### Note

When initializing temperature calibration data, all settings need to be initialized. Perform initialization by referring to "Resetting to factory default settings" (page 83). When initialization is performed, all saved data is deleted. Copy or transfer necessary data to a PC for storage.

---

## ■ General settings

### ● Setting the auto stability and auto hold function

This instrument has auto stability mode and auto hold mode.







#### • Auto stability mode (displayed as AS)

When the criterion for stability judgment is fulfilled during measurement, the component icon lights and the measured value is fixed. Once the value deviates from the stability judgment criterion, the measured value is released and displays instantaneous value.

#### • Auto hold mode (displayed as AH)

When the criterion for stability judgment is fulfilled during measurement, the component icon and the HOLD icon light and the measured value is fixed. To release the measured value, press the  key. Once a measured value is fixed, the measured value is not released automatically even when the state deviates from the stability judgment criterion.

#### • Setting procedure

1. Press the  key to enter the setting mode.
2. Press the   keys to select "GEN" (general setting) and then press the  key.
3. Press the   keys to select "MEAS" (measurement setting) and then press the  key.

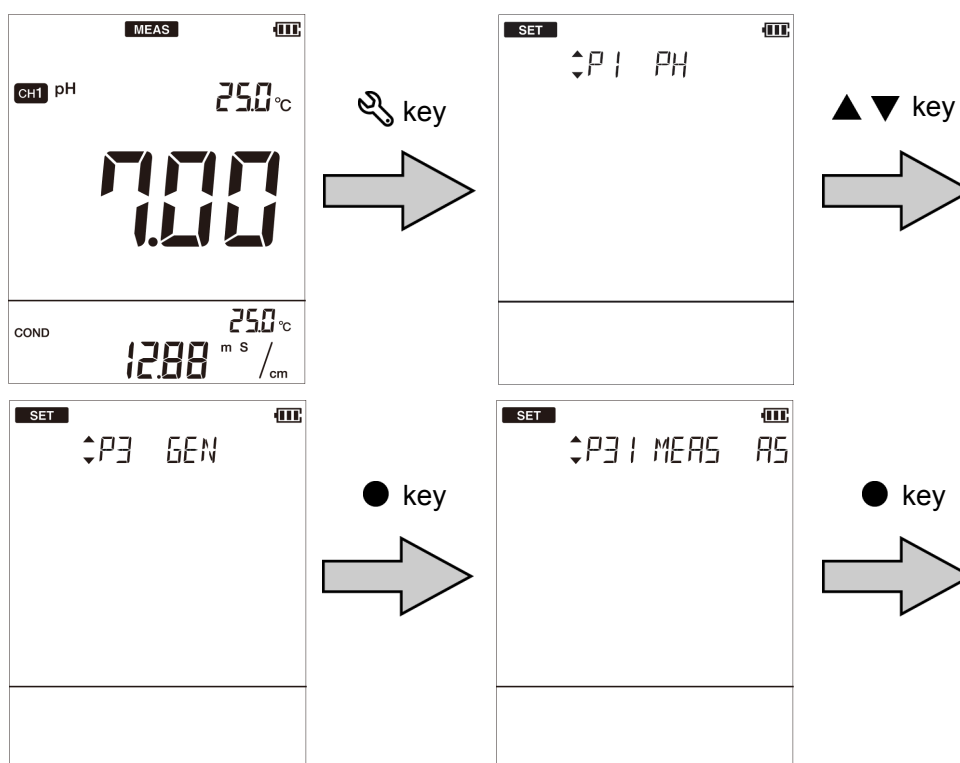

#### Note

The general setting is common in both CH1 and CH2.

4. Select "AS" to set the auto stability, or select "AH" to set the auto hold. And then press the ● key to confirm selection.

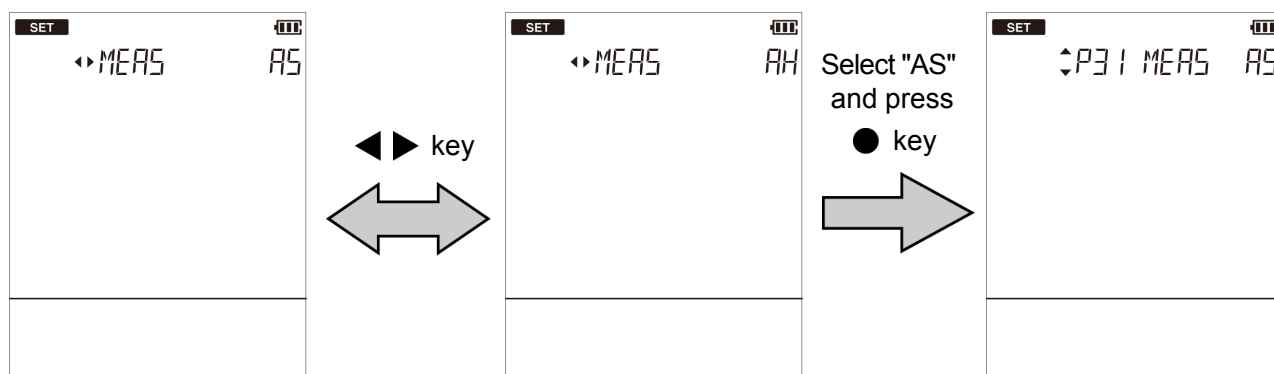

To return to the measurement mode, press the ↻ key.

---

### Note

In the calibration mode, the auto stability mode always works.

---

### Tip





The stability judgment criteria are the same for both the auto stability mode and the auto hold mode.

---

## ● Changing the automatic power off setting (default: 30 min)

You can set the instrument to automatically turn OFF when there is no key operation for a certain period of time.

This function is disabled during automatic data memory saving or remote operation using an external device.

1. Press the  key to enter the setting mode.
2. Press the   keys to select "GEN" (general setting) and then press the  key.

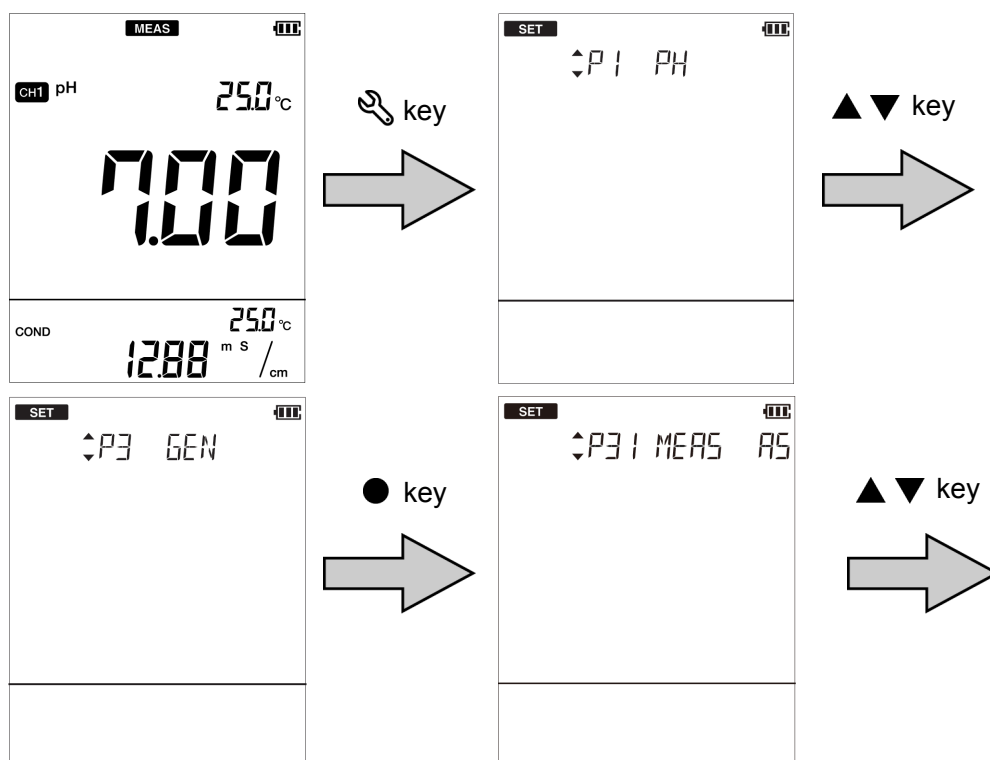

3. Press the   keys to select "AUTO OFF" (automatic power off setting) and then press the  key.

4. Enter the automatic power off time and press the ● key.

The setting range is 0 min to 30 min.



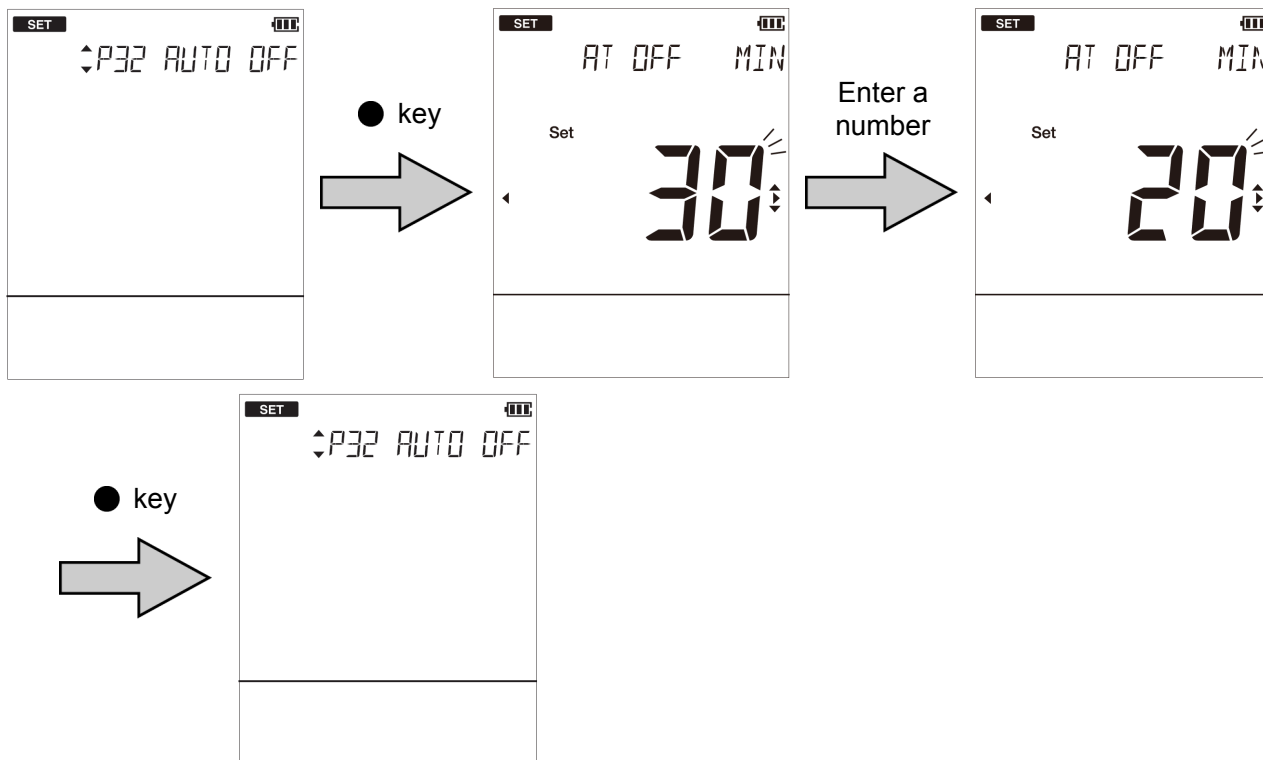

"0" indicates the automatic power off is "OFF."



To return to the measurement mode, press the  key.

## ● Resetting to factory default settings

The instrument settings can be reset to the factory default settings. The calibration data is deleted but the data of date and time, and the saved data are not deleted. Make sure there will be no problems before using this function. When this function is used, the temperature calibration data is also initialized.

1. Press the  key to enter the setting mode.
2. Press the   keys to select "GEN" (general setting) and then press the  key.

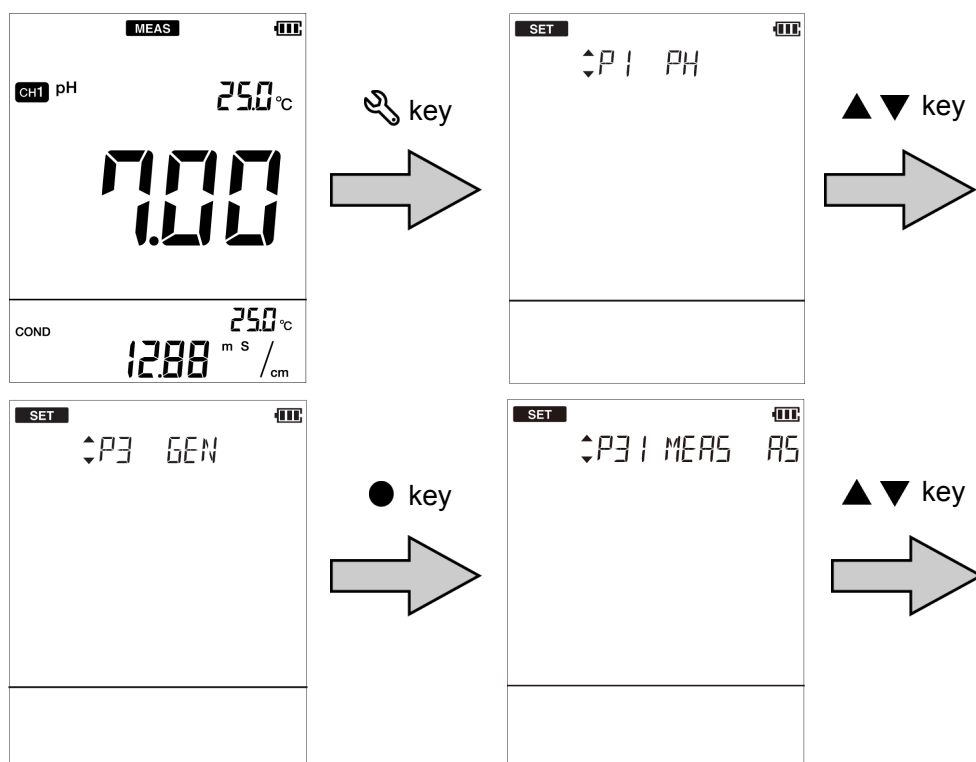

3. Press the   keys to select "RESET" (initialize) and then press the  key.



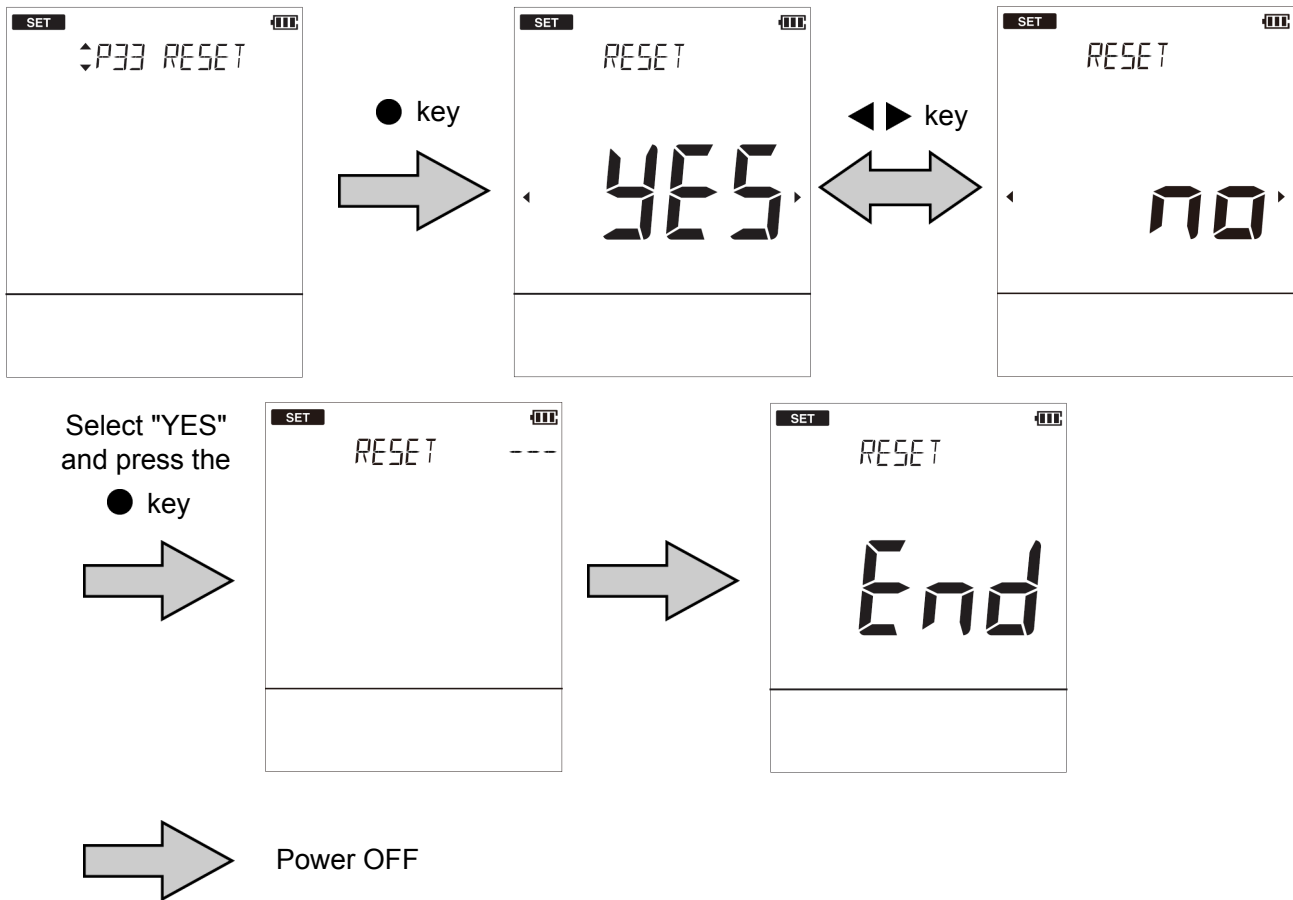

4. Select "YES" to initialize the settings to the factory default settings, or select "NO" to cancel initialization. And then press the ● key to confirm selection. When "YES" is selected, "END" appears after the settings are initialized and then the instrument is automatically powered OFF.





## ● Setting the date and time

When using the instrument for the first time or after replacing the batteries, set the date and time. After setting, the date and time data is displayed correctly when saving data in the internal memory. If the setting is incorrect, the date and time of saved data becomes incorrect.

1. Press the  key to enter the setting mode.
2. Press the   keys to select "GEN" (general setting) and then press the  key.

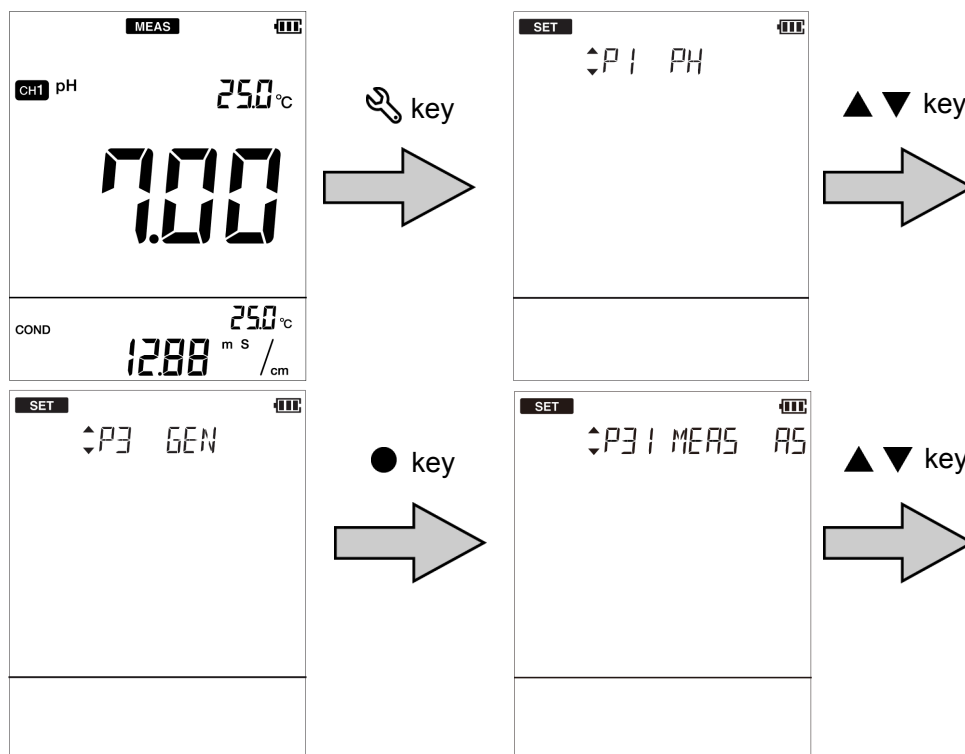

3. Press the ▲▼ keys to select "DATE" (date and time setting) and then press the ● key.
4. Enter "YEAR" (current year) and press the ● key.
5. In the same way, set "MONTH" (month), "DAY" (date) and "TIME" (hour and minute), in that order.
6. Press ● key to confirm.

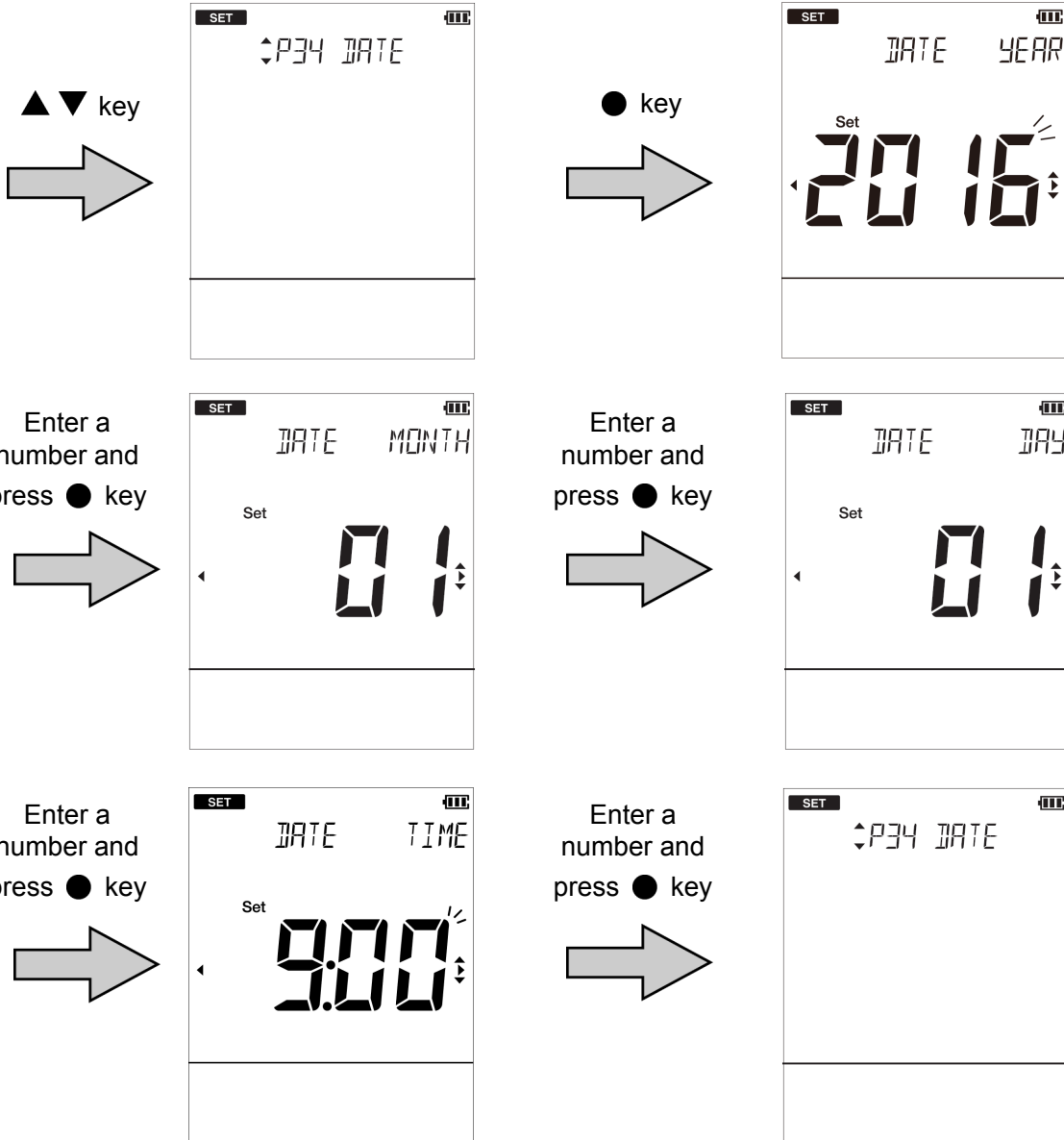

To return to the setting mode, press the ⏪ key.





## ● Performing test printing of the printer unit

In order to check whether the printer unit is operating correctly or there is a printer communication problem, you can perform test printing.

Connect the instrument and a printer correctly and perform the following procedure for test printing. As a result of test printing, if the printout is as shown below, the printer unit is operating correctly.

```

! " # $ % & ' ( ) * + , - . / 0 1 2 3
4 5 6 7 8 9 : ; < = > ? @ A B C D E F G
H I J K L M N O P Q R S T U V W X Y Z [
¥ ] ^ _ ` a b c d e f g h i j k l m n o
p q r s t u v w x y z { | }
    
```

1. Press the  key to enter the setting mode.
2. Press the   keys to select "GEN" (general setting) and then press the  key.

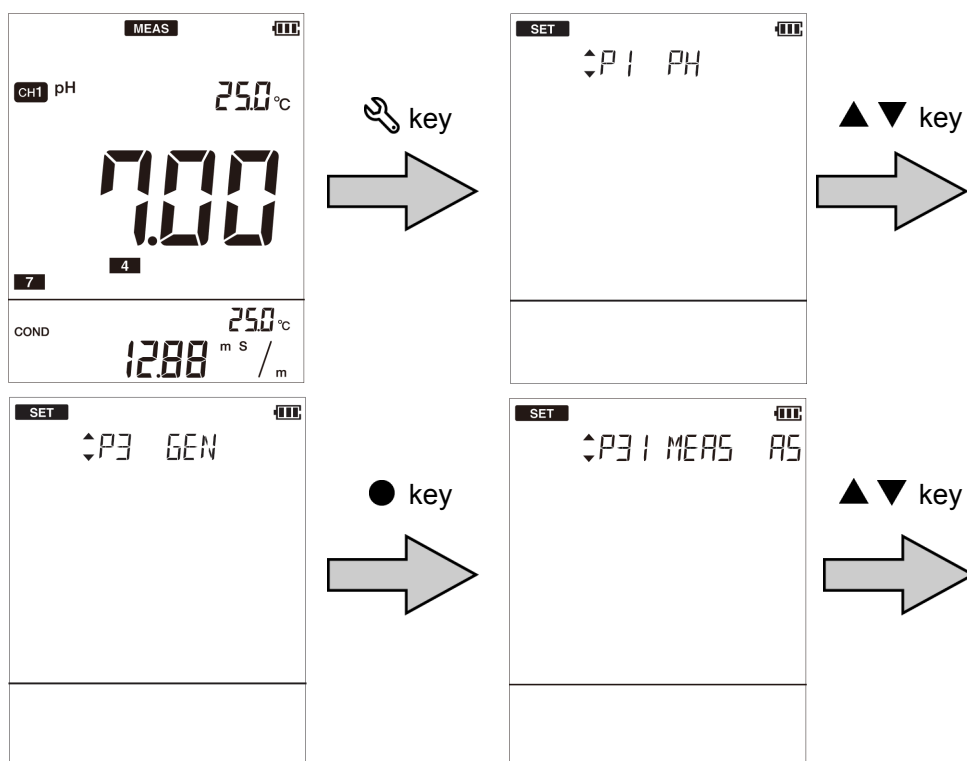

3. Press the ▲ ▼ keys to select "PRINT" (test print) and then press the ● key. Printing starts automatically. When printing ends, the printer icon lights and "END" appears. Press the ● key or the 🔧 key.

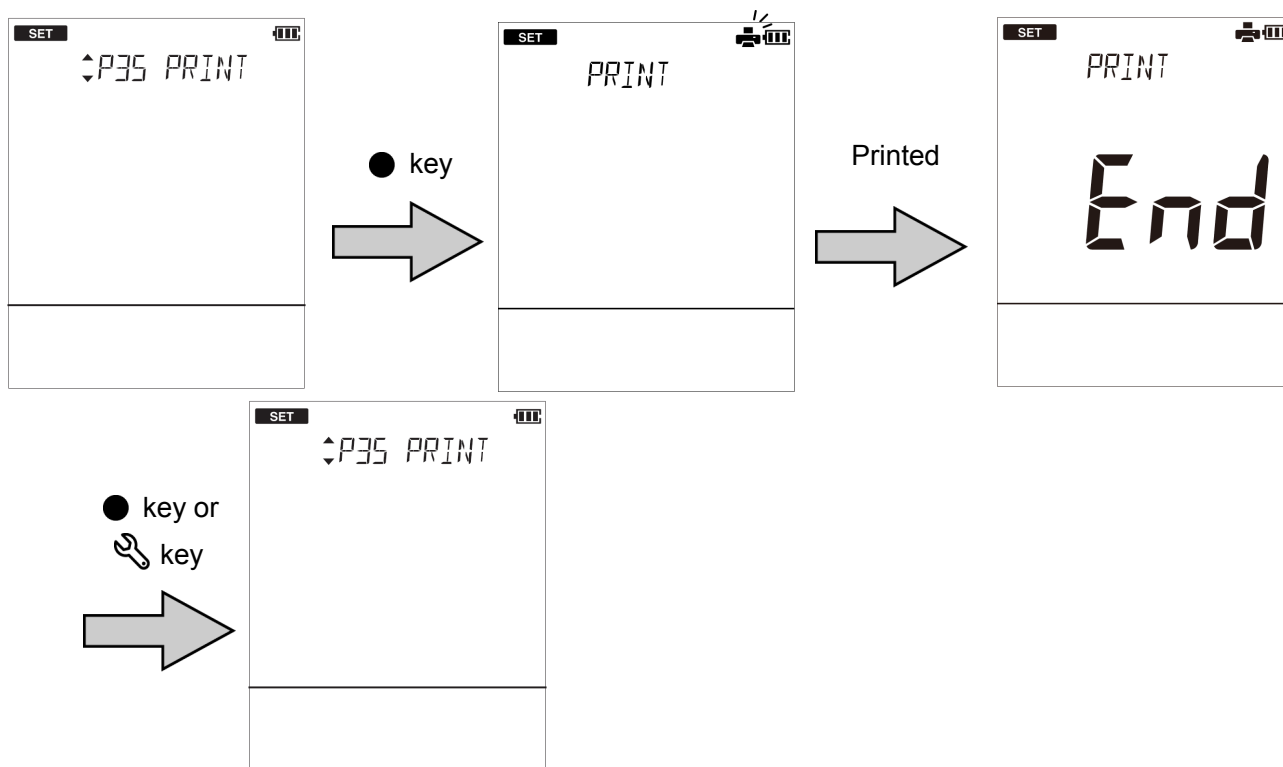

To return to the measurement mode, press the 🔧 key.

## ■ Other settings

### ● Printing measured values and calibration data

Print out the measured value or calibrated value displayed on the instrument, or the measurement data or the calibration data saved in the instrument. If the repeatability is inspected, the inspection data is printed out with the calibration data.

Pressing the ● key starts printing during displaying the data you want to print. Use the printer cable to connect the printer unit with the instrument beforehand. If the automatic data memory is set to "ON", you cannot print out in the measurement mode.

---

#### Reference

For details of how to display measurement data and calibration data, refer to the respective section.

"Displaying saved data" (page 64)

"Displaying the latest calibration and inspection data" (page 70)

---

Refer to the following table for the pH (two point calibration) and conductivity.

## Other settings

< The data saved in internal memory >

Printout format	Description
Memory Num : 0001	Data number
Date : 2016/01/01	Measurement date
Time : 09:00	Measurement time
Channel : 1	Measurement Channel
pH : 5.22	Measured value Out of measure range Over: OR Under: UR
Temperature : 25.0°C MTC	Temperature value and temperature setting Out of measure range Over: OR Under: UR
Inst. model : LAQUAact-PC110	Instrument model
Inst. SN : KL1TSN20	Instrument serial number
Elect. status : GOOD	Electrode status based on calibration result
Memory Num : 0001	Data number
Date : 2016/01/01	Measurement date
Time : 09:00	Measurement time
Channel : 2	Measurement Channel
COND : 1.121 mS/m	Measured value
Temperature : 25.0°C MTC	Temperature value and temperature setting
Inst. model : LAQUAact-PC110	Instrument model
Inst. SN : KL1TSN20	Instrument serial number

&lt; Calibration data (pH, inspection was performed) &gt;

Printout format	Description
Inst. model : LAQUAact-PC110	Instrument model
Inst. SN : KL1TSN20	Instrument serial number
Elect. status : GOOD	Electrode status based on calibration result
Offset : 0.7 mV	Asymmetry potential of calibration data
Sensitivity	Sensitivity of calibration data
pH 4.01 - 6.86 : 98.9%	
Repeatability : 0.01	Repeatability of calibration data
Calibration data	
Date : 2016/01/01	Calibration date
Time : 09:00	Calibration time
pH 4.01 : 176.9 mV	Measurement potential
: 25.0°C ATC	Temperature value and temperature setting
pH 6.86 : 7.6 mV	Measurement potential
: 25.0°C ATC	Temperature value and temperature setting
Inspection before use	
pH 6.85 : 7.8 mV	Measurement potential at time of repeatability inspection
: 25.0°C ATC	Temperature value and temperature setting

&lt; Calibration data (pH, inspection was not performed) &gt;

Printout format	Description
Inst. model : LAQUAact-PC110	Instrument model
Inst. SN : KL1TSN20	Instrument serial number
Elect. status : GOOD	Electrode status based on calibration result
Offset : 0.7 mV	Asymmetry potential of calibration data
Sensitivity	Sensitivity of calibration data
pH 4.01 - 6.86 : 98.9%	
Calibration data	
Date : 2016/01/01	Calibration date
Time : 09:00	Calibration time
pH 4.01 : 176.9 mV	Measurement potential
: 25.0°C ATC	Temperature value and temperature setting
pH 6.86 : 7.6 mV	Measurement potential
: 25.0°C ATC	Temperature value and temperature setting

## Other settings

< Calibration data (conductivity) >

Printout format	Description
Inst. model : LAQUAact-PC110	Instrument model
Inst. SN : KL1TSN20	Instrument serial number
CELL :	Cell constant
R1 (0.00-19.99 $\mu\text{S}/\text{cm}$ )	Measurement range (range 1)
1.000 $\times$ 1 $\text{cm}^{-1}$	Cell constant (range 1)
R2 (18.0-199.9 $\mu\text{S}/\text{cm}$ )	Measurement range (range 2)
1.000 $\times$ 1 $\text{cm}^{-1}$	Cell constant (range 2)
R3 (180-1999 $\mu\text{S}/\text{cm}$ )	Measurement range (range 3)
1.000 $\times$ 1 $\text{cm}^{-1}$	Cell constant (range 3)
R4 (1.80-19.99 $\text{mS}/\text{cm}$ )	Measurement range (range 4)
1.000 $\times$ 1 $\text{cm}^{-1}$	Cell constant (range 4)
R5 (18.0-200.0 $\text{mS}/\text{cm}$ )	Measurement range (range 5)
1.000 $\times$ 1 $\text{cm}^{-1}$	Cell constant (range 5)
Calibration data	
Date : 2016/01/01	Calibration date
Time : 09:00	Calibration time
1413 $\mu\text{S}/\text{cm}$ :	Calibration value
: 25.0 $^{\circ}\text{C}$ ATC	Calibration Temperature and temperature setting
111.8 $\text{mS}/\text{cm}$ :	Standard value
: 25.0 $^{\circ}\text{C}$ ATC	Calibration Temperature and temperature setting

Tip

The conductivity range marked with "0" (Ex. oR1) indicates calibrated conductivity range.



## ● Transferring saved data to a PC

By using a serial cable to connect the instrument to a PC, you can transfer the saved data to the PC and edit it. Connect the RS-232C connector at the instrument side to the serial port on the PC.

To save and edit data, please download the software "FD-70" from our website after the registration.

For details of how to use the "FD-70", refer to the "FD-70" instruction manual, which you can download from our website as well.

The required PC specifications and recommended PC specifications for using the "FD-70" are shown in the following table.

Item	Required PC specifications	Recommended PC specifications
Memory	32 bit: 1 GB or more 64 bit: 2 GB or more	
CPU	1 GHz or more	
HDD free space	5 GB or more	10 GB or more
OS	Windows 7, Windows 8 (8.1), or Windows 10	
Display	Super VGA (800 × 600) or more	
Connector	Serial connector (D-Sub 9 pin)	

### Note

- If you are not using the RS-232C communication, close the connector cover tightly.
- While using the RS-232C communication, the instrument is not dust-proof or waterproof. Do not use the RS-232C communication in a dusty place or with wet hands.

## ● Operating the instrument from an external device

You can remotely operate the instrument from an external device (such as PC) via the RS-232C communication. Use the serial cable to connect the serial connector on the instrument side and the serial port on the PC.

When using this function, pay attention to the following points.

- Use the optional serial cable to connect the unit to a PC.
- Make sure that the transfer formats used in the instrument and a PC are the same. When different transfer formats are used, a communication error occurs and the online mode does not start up, and as a result RS-232C communication cannot be performed. Also, when the transfer format is changed, turn OFF the power of the instrument and PC and then reboot them.

The transfer format of the instrument is as follows.

- Baud rate: 2400 bps
- Character length: 8 bits
- Parity: None
- Stop bit: 1 bit

You can download a list of communication commands from our website. In order to download the list, you need to complete user registration.

---

### Note

- If you are not using the RS-232C communication, close the connector cover tightly.
  - While using the RS-232C communication, the instrument is not dust-proof or waterproof. Do not use the RS-232C communication in a dusty place or with wet hands.
-

# Maintenance

This section describes maintenance of the instrument and the electrodes that are used with the instrument. To use them for a long period, perform the described maintenance procedures appropriately.

## ● Contact for maintenance

Please contact your dealer for the product maintenance.

## ● Maintenance and storage of the instrument

- If the instrument becomes dirty, wipe it gently with a soft dry cloth. If it is difficult to remove the dirt, wipe it gently with a cloth moistened with alcohol.
- The instrument is made of solvent resistant materials but that does not mean it is resistant to all chemicals. Do not dip the instrument in strong acid or alkali solution, or wipe it with such solution.
- Do not wipe the instrument with a polishing powder or other abrasive compound.

## ● Environmental conditions for storage

Temperature: 0°C to 45°C

Humidity: under 80% in relative humidity and free from condensation

Avoid the following conditions.

- Dusty place
- Strong vibration
- Direct sunlight
- Corrosive gas environment
- Close to an air-conditioner
- Direct wind

## ● Maintenance and storage of the pH electrode

For the detailed procedures for maintaining and storing electrodes, refer to the instruction manual for each electrode. This section describes an overview of the procedures for maintenance and storage to be performed as part of daily use.

### • How to clean the electrode

When the tip of an electrode (responsive membrane and liquid junction) becomes dirty, the response speed may become slow or an error may occur in the measurement results. To avoid such error, clean the electrode. For dirt that cannot be removed by pure water (or deionized water), use the cleaning solution indicated below depending on the type of dirt. After cleaning, rinse the electrode with pure water (or deionized water).

Type of dirt	Cleaning solution
General	Diluted neutral cleaning solution
Oil	Alcohol, or diluted neutral cleaning solution
Inorganic substance	1 mol/L HCl or electrode cleaning solution (model 220)
Protein	Cleaning solution including protein-removing enzyme (model 250)
alkali	Immerse 1 mol/L HCl or electrode cleaning solution (model 220) in 1 h to 2 h

### • Daily storage of the electrode

If the electrode becomes dry, the response will become slow. Store in a moist atmosphere. Follow the steps below to properly store the electrode.

1. Clean the electrode well with pure water (or deionized water) to remove sample completely, and close the internal solution filler port.
2. Clean inside of the protective cap with pure water (or deionized water), then add enough pure water (or deionized water) to soak the sponge.
3. Attach the protective cap.

### • When the electrode will not be used for a long period

To store the electrode for a long period, follow the electrode storage procedure above, and in addition, use a dropper or similar tool to replace the reference electrode internal solution (model 300) with new solution. Replace the internal solution once every three to six months.

## ● Maintenance and storage of the ORP electrode

For the detailed procedures for maintaining and storing electrodes, refer to the instruction manual for each electrode. This section describes an overview of the procedures for maintenance and storage to be performed as part of daily use.

### • How to clean the electrode

When the tip of an electrode (responsive membrane and liquid junction) becomes dirty, the response speed may become slow or an error may occur in the measurement results. To avoid such error, clean the electrode. For dirt that cannot be removed by pure water (or deionized water), use the cleaning solution indicated below depending on the type of dirt. After cleaning, rinse the electrode with pure water (or deionized water).

Type of dirt	Cleaning solution
General	Diluted neutral cleaning solution
Oil	
Inorganic substance	Immerse dilute nitric acid (1:1 nitric acid)

### • Daily storage of the electrode

If the electrode becomes dry, the response will become slow. Store in a moist atmosphere. Follow the steps below to properly store the electrode.

1. Clean the electrode well with pure water (or deionized water) to remove sample completely, and close the internal solution filler port.
2. Clean inside of the protective cap with pure water (or deionized water), then add enough pure water (or deionized water) to soak the sponge.
3. Attach the protective cap.

### • When the electrode will not be used for a long period

To store the electrode for a long period, follow the electrode storage procedure above, and in addition, use a dropper or similar tool to replace the reference electrode internal solution (model 300) with new solution. Replace the internal solution once every three to six months.

## ● Checking the state of the ORP electrode

ORP standard solution can be used to check the state of the ORP electrode. This solution is only used to check the state of the ORP electrode; it is not used to calibrate the instrument. The procedure for checking the electrode using HORIBA ORP standard solution powder 160-22 or 160-51 is explained below.

**1. Add one bag of 160-22 or 160-51 standard solution powder to 250 mL of deionized water and mix thoroughly.**

When mixing, the excess quinhydrone (a black powder) will float to the surface of the solution.

**2. Immerse a washed and dried ORP electrode in the prepared standard solution and measure the mV value.**

If the electrode and the instrument are working properly, numerical values within  $\pm 15$  mV of those indicated below should be obtained.

The ORP value varies by temperature. Check the appropriate ORP value for the temperature of the standard solution.

**3. If the ORP value is not within  $\pm 15$  mV, replace the reference electrode internal solution.**

If the surface of the metal electrode is dirty, wipe it gently with a soft material such as absorbent cotton moistened with alcohol or a neutral cleaning solution, or immerse in dilute nitric acid (1:1 nitric acid) to remove the dirt.

**4. Repeat the measurement.**

If the ORP value is within  $\pm 15$  mV, the electrode is normal.

If not within  $\pm 15$  mV, the electrode may have failed. Replace the electrode.

### Note

- If the prepared standard solution is left out in air for one hour or more, that the ORP value might change. Do not use the ORP standard solution that was prepared more than an hour before.
- When measuring a solution that has low concentrations of oxidants and reductants after conducting an operational check using a standard substance, the measured values may not stabilize or the repeatability might be poor. If this is the case, use the ORP electrode after immersing it in the solution again and mixing it thoroughly.

### • ORP value based on the temperature of ORP standard solution

Temp. (°C)	160-22 Phthalic-acid chloride + quinhydrone (mV)	160-51 Neutral phosphate + quinhydrone (mV)
5	274.2	111.9
10	270.9	106.9
15	266.8	101.0
20	262.5	95.0
25	257.6	89.0
30	253.5	82.7
35	248.6	76.2
40	243.6	69.0

## ● Maintenance and storage of the conductivity cell

For the detailed procedures for maintaining and storing cells, refer to the instruction manual for each cell. This section describes an overview of the procedures for maintenance and storage to be performed as part of daily use.

### • How to clean the cell

Always wash the cell in pure water (or deionized water) after every measurement. When the response is slow or residue from the sample adheres to the cell, use the appropriate method below to clean the cell, and then wash again with pure water (or deionized water).

Type of dirt	Cleaning solution
General	Diluted neutral cleaning solution
Inorganic substance	Ethanol (keep the ethanol away from plastic parts)
Scale that formed during long term storage	A commercially available scale remover (neutral cleansing solution for kitchen use, etc.) diluted by a factor of 100. If this does not remove the scale, use diluted solution that contains oxygen bleach (sodium percarbonate) or chlorine bleach (sodium hypochlorite).

### • Daily storage of the cell

If the cell is stored in a dry state, the cell constant will change. Store with the black electrode part immersed in pure water (or deionized water), or with the protective cap filled with pure water (or deionized water) and attached to the cell.

### • When the electrode will not be used for a long period

To store the cell for a long period, wash it well and attach the protective cap filled with pure water (or deionized water).

# MEMO





# How to Resolve Errors or Troubles

This section describes the causes of typical problems and the actions to be taken, including questions frequently asked by customers. Check these before contacting us.

## ■ When an error message appears

If "ERR No.00XX" is displayed while you are using the instrument, check the error in the error list below, and check the cause and action to be taken.

ERR No.	Description	Definition of error
0001	Memory error	Data cannot be read from or written to the internal memory.
0002	Empty battery level	The battery level is empty.
0004	Asymmetric potential error	The asymmetric potential of the electrode is out of the range of $\pm 45$ mV.
0005	Electrode sensitivity error	The electrode sensitivity is either 105% or more or 85% or less than the theoretical sensitivity.
0006	Maximum calibration points exceeded	6th point calibration is attempted.
0007	Cannot identify standard solution	The instrument cannot identify the standard solution.
0008	Calibration interval error	Exceeds the calibration interval setting.
0009	Printer error	There is a problem with the printer.
0010	Memory full	The number of the data saved has exceeded the specified number of items.
0011	Cell constant is out of range	Cell constant is out of automatic calculation range.

### ● ERR No.0001 Memory error

Data cannot be read from or written to the internal memory.

Cause	How to solve problem
The instrument does not start properly due to noise or other at power ON.	Remove the batteries, disconnect the AC adapter, and then press the  key.
The defect of the internal IC	Contact your dealer for repair.

### ● ERR No.0002 Empty battery level

The instrument cannot operate properly because the battery level is empty.

Cause	How to solve problem
The battery level is empty.	Replace the batteries or connect the AC adapter (option).

### ● ERR No.0004 Asymmetric potential error

Detected that the asymmetric potential of the electrode is out of the setting range that allows proper measurement.

Cause	How to solve problem
The electrode is dirty.	Clean the electrode.
The electrode is cracked.	Replace the electrode.
The standard solution concentration is fluctuating.	Replace the internal solution in the reference electrode.
The electrode is not connected correctly.	Connect the electrode correctly.
Electrode is not immersed enough to cover liquid junction.	The electrode must be immersed up to the liquid junction. As a guide, immerse to at least 3 cm from the tip of the electrode.
There is a problem with the standard solution.	Use new standard solution.

### ● ERR No.0005 Electrode sensitivity error

Detected that the electrode sensitivity is out of the setting range that allows proper measurement.

Cause	How to solve problem
The electrode is dirty.	Clean the electrode.
The electrode is cracked.	Replace the electrode.
Calibration was not performed correctly.	Perform calibration correctly.
The electrode is not connected correctly.	Connect the electrode correctly.
Electrode is not immersed enough to cover liquid junction.	The electrode must be immersed up to the liquid junction. As a guide, immerse to at least 3 cm from the tip of the electrode.
There is a problem with the standard solution.	Use new standard solution.

### ● ERR No.0006 Maximum calibration points exceeded

Attempted to perform 6th point calibration during pH calibration.

Cause	How to solve problem
6th point calibration is attempted.	Up to five points can be calibrated.

### ● ERR No.0007 Cannot identify standard solution

Unable to automatically detect the standard solution during pH calibration.

Cause	How to solve problem
There is a problem with the standard solution.	Use new standard solution.
Settings about the standard solution do not match the instrument.	Check if the instrument settings and the specifications of the standard solution are compatible.
The electrode is dirty.	Clean the electrode.
The electrode is cracked.	Replace the electrode.
The standard solution concentration is fluctuating.	Replace the internal solution in the reference electrode.
Electrode is not immersed enough to cover liquid junction.	The electrode must be immersed up to the liquid junction. As a guide, immerse to at least 3 cm from the tip of the electrode.

### ● ERR No.0008 Calibration interval error

- More than the set number of days has elapsed since calibration was last performed.
- The calibration interval alarm is "ON" and calibration has not been performed.

Cause	How to solve problem
Calibration has not been performed for the set number of days of the calibration interval or longer.	Perform calibration.
The calibration interval alarm is "ON" and calibration has not been performed.	Perform calibration.

### ● ERR No.0009 Printer error

An error occurred during printer communication.

Cause	How to solve problem
There is a problem with the printer unit connection.	Check the printer connection, and connect the instrument and printer again.
The defect of the printer	Consult your dealer.

### ● ERR No.0010 Memory full

Attempted to save more than the specified number of items.

Cause	How to solve problem
Saving more than specified number of items.	The maximum number of savable items of data is 1000. Copy or transfer necessary data to a PC and delete the data from the memory ("Deleting all saved data" (page 68)).

### ● ERR No.0011 Cell constant is out of range

Cell constant is out of setting range.

Cause	How to solve problem
End of cell life	Replace the conductivity cell.
There is a problem with the standard solution	Use new standard solution.

## ■ Troubleshooting

This section describes causes and actions to take for problems that customers frequently ask us.

### ● The indicated value fluctuates

#### < Problem with the electrode >

Cause	How to solve problem
The electrode is dirty.	Clean the electrode.
The electrode is cracked.	Replace the electrode.
The wrong internal solution is being used.	Use the correct internal solution.
There are air bubbles on the electrode.	Shake the electrode to remove the air bubbles.
The level of internal solution in reference electrode is low.	Replenish the internal solution of the reference electrode until it is higher than the level of the sample.

#### < Problem with the instrument >

Cause	How to solve problem
There is a motor or other device causing electrical interference.	Measure at a place where no influence from induction is given. Ground all AC-powered equipment.
The electrode is not connected correctly.	Connect the electrode correctly.

#### < Problem with the sample >

Cause	How to solve problem
Electrode is not immersed enough to cover liquid junction.	The electrode must be immersed up to the liquid junction. As a guide, immerse to at least 3 cm from the tip of the electrode.
The stability of electrode is affected by the sample solution.	It is important to select an electrode that is appropriate for the sample. Consult your dealer. To confirm an electrode that is appropriate for the sample, check the pH electrode selection guide in our catalogue, or refer to our website.

● **The response is slow**

Cause	How to solve problem
The electrode is dirty.	Clean the electrode.
The electrode is cracked.	Replace the electrode.
The wrong internal solution is being used.	Use the correct internal solution.
The response of electrode is affected by the sample solution.	It is important to select an electrode that is appropriate for the sample. Consult your dealer. To confirm an electrode that is appropriate for the sample, check the pH electrode selection guide in our catalogue, or refer to our website.

● **The indicated value does not change/No response**

Cause	How to solve problem
The electrode is cracked.	Replace the electrode.
The electrode is not connected correctly.	Connect the electrode correctly.
Keys are locked.	Turn OFF the power, remove the batteries, and then turn ON the power again.
The instrument is in HOLD state.	Cancel the HOLD state.
Instrument defect	Consult your dealer.

## ● The measured value is out of the measurement range

When the measured value is below the display range, "Ur" appears. When the measured value is over the display range, "Or" appears.

Cause	How to solve problem
Sample is out of the measurement range.	Use a sample within the measurement range.
Electrode is not immersed enough to cover liquid junction.	The electrode must be immersed up to the liquid junction. As a guide, immerse to at least 3 cm from the tip of the electrode.
The electrode cable is broken.	Replace the electrode.
Calibration is not performed or performed incorrectly.	Perform calibration correctly.
Instrument defect	Check as explained below.

### • How to check for instrument defect

Short the metal part of the outer tube to the center pin of the electrode connector of the corresponding channel of the instrument. If "Ur" or "Or" appears in this condition, consult your dealer.

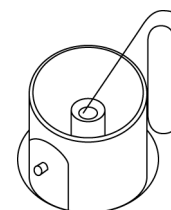

## ● Repeatability of the measured value is poor

Cause	How to solve problem
Effect of the sample solution	Repeatability becomes poor when the pH of the sample changes over time.
The electrode is dirty.	Clean the electrode. (Electrode cleaning solution 220 or 250 is recommended.)
The electrode is cracked.	Replace the electrode.
The internal solution of the electrode runs out or contaminated.	Replace the internal solution with new one.
The level of internal solution in reference electrode is low.	Replenish the internal solution of the reference electrode until it is higher than the level of the sample.

## ● Nothing appears when the power is turned ON

Cause	How to solve problem
Power is not supplied.	Insert batteries or connect the AC adapter (option).
Battery polarity (+, -) is reversed.	Insert the batteries with the polarity (+, -) correctly oriented.
Battery life is low.	Replace the batteries or connect the AC adapter (option).
Instrument defect	Consult your dealer.

## ● Swelling of operation key sheet

Cause	How to solve problem
Using the instrument at high elevation or other location where the air pressure is different from sea level.	To eliminate the pressure difference between the inside and outside of the instrument, briefly open and then close the AC adapter cover. After opening, correctly close the cover to maintain dust and water proofing.
Instrument defect	Consult your dealer.

## ● Part of the display is missing

Cause	How to solve problem
Instrument defect	Check the display in full screen state when turning ON the power of the instrument.



# Appendix

This section describes the specifications of the instrument, default settings, measurement principles, and other technical information.

Options for the instrument are also described.

## ■ Main specifications

Item	Description
Model	LAQUAact-PC110
Brand (pet name)	LAQUAact
Series name	Portable pH · Water Quality Meter
Model description	pH/ORP/Conductivity Meter
Measurement parameters	pH, mV (ORP), conductivity, salinity, TDS, resistivity, temperature
Operating ambient temperature, humidity	0°C to 45°C 80% or less in relative humidity (no condensation)
Power	AAA alkaline batteries (LR03) or AAA Ni-MH rechargeable batteries × 2 AC adapter 100 V to 240 V, 50/60 Hz, 0.37 A (option)
Dimensions	Approx. 67 [80] (W) × 170 (D) × 28 [42] (H) mm (The figures in square bracket are maximum thicknesses.)
Mass	Approx. 285 g (without batteries)

· Specification of each measurement parameter

Measurement parameter	Item	Description
pH	Measuring principle	Glass electrode
	Display range	pH -2.00 to pH 16.00
	Measuring range	pH 0.00 to pH 14.00
	Resolution	0.01 pH
	Accuracy	±0.01 pH
mV (ORP)	Measuring range	±2000 mV
	Resolution	1 mV
	Accuracy	1 mV or 1% of the read value, whichever is greater
Temperature	Measuring principle	Thermistor method
	Display range	-30.0°C to 130.0°C
	Measuring range	0.0°C to 100.0°C
	Resolution	0.1°C
	Accuracy	±0.4°C

## Main specifications

Measurement parameter	Item	Description
Conductivity	Measuring principle	2 AC bipolar method
	Measuring range (Display range)	Cell constant 1 cm <sup>-1</sup> : 0.00 μS/cm to 200.0 mS/cm Cell constant 0.1 cm <sup>-1</sup> : 0.000 μS/cm to 20.00 mS/cm Cell constant 10 cm <sup>-1</sup> : 0.0 μS/cm to 2.000 S/cm
	Resolution	0.05% of full scale
	Accuracy	±0.6% of full scale (18.0 mS/cm to 200.0 mS/cm: ±1.5% of full scale)
	Repeatability	±0.6% of full scale
Salinity	Measuring principle	Conversion from conductivity value
	Measuring range (Display range)	0.00% to 10.00% (0.0 ppt to 100.0 ppt)
	Accuracy	±0.2% of full scale
	Resolution	0.01% (0.1 ppt)
TDS	Measuring principle	Conversion from conductivity value
	Measuring range (Display range)	0.00 mg/L to 100 g/L TDS factor: 0.40 to 1.00
	Accuracy	±0.1% of full scale
	Resolution	0.01 mg/L
Resistivity	Measuring principle	Conversion from conductivity value
	Measuring range (Display range)	Cell constant 1 cm <sup>-1</sup> : 0.000 kΩ·cm to 20.00 MΩ·cm Cell constant 0.1 cm <sup>-1</sup> : 0.00 kΩ·cm to 200.0 MΩ·cm Cell constant 10 cm <sup>-1</sup> : 0.0 Ω·cm to 2.000 MΩ·cm
	Resolution	0.05% of full scale
	Accuracy	±0.6% of full scale (1.80 MΩ·cm to 20.00 MΩ·cm: ±1.5% of full scale)
	Repeatability	±0.5% of full scale ±1 digit

### Tip

Accuracy is the difference between the measured value and the simulation value when the simulation value is inputted to the instrument.

## ● Table of conductivity cell range

• Unit: S/m

Range	Cell constant		
	1000 m <sup>-1</sup>	100 m <sup>-1</sup>	10 m <sup>-1</sup>
20.0 to 200.0 S/m			
2.00 to 19.99 S/m			
0.200 to 1.999 S/m			
20.0 to 199.9 mS/m			
2.00 (0.00) to 19.99 mS/m			
0.200 (0.000) to 1.999 mS/m			
0.0 to 199.9 μS/m			

• Unit: S/cm

Range	Cell constant		
	10 cm <sup>-1</sup>	1 cm <sup>-1</sup>	0.1 cm <sup>-1</sup>
0.200 to 2.000 S/cm			
20.0 to 199.9 mS/cm			
2.00 to 19.99 mS/cm			
200 to 1999 μS/cm			
20.0 (0.0) to 199.9 μS/cm			
2.00 (0.00) to 19.99 μS/cm			
0.000 to 1.999 μS/cm			

• Unit: mS/cm FIX

Range	Cell constant		
	10 cm <sup>-1</sup>	1 cm <sup>-1</sup>	0.1 cm <sup>-1</sup>
200.0 to 2000 mS/cm			
20.00 to 199.9 mS/cm			
2.000 to 19.99 mS/cm			
0.200 (0.000) to 1.999 mS/cm			
0.020 (0.000) to 0.199 mS/cm			
0.002 to 0.019 mS/cm			
0.000 to 0.002 mS/cm			

● **Table of conductivity cell range (resistivity range)**

• Unit:  $\Omega \cdot m$

Range	Cell constant		
	$10 m^{-1}$	$100 m^{-1}$	$1000 m^{-1}$
0.200 to 2.000 $M\Omega \cdot m$			
20.0 to 199.9 $k\Omega \cdot m$			
2.00 to 19.99 $k\Omega \cdot m$			
0.200 to 1.999 $k\Omega \cdot m$			
20.0 (0.0) to 199.9 $\Omega \cdot m$			
2.00 (0.00) to 19.99 $\Omega \cdot m$			
0.000 to 1.999 $\Omega \cdot m$			

• Unit:  $\Omega \cdot cm$

Range	Cell constant		
	$0.1 cm^{-1}$	$1 cm^{-1}$	$10 cm^{-1}$
20.0 to 199.9 $M\Omega \cdot cm$			
2.00 to 19.99 $M\Omega \cdot cm$			
0.200 to 1.999 $M\Omega \cdot cm$			
20.0 to 199.9 $k\Omega \cdot cm$			
2.00 (0.00) to 19.99 $k\Omega \cdot cm$			
0.200 (0.000) to 1.999 $k\Omega \cdot cm$			
0.0 to 199.9 $\Omega \cdot cm$			

## ■ Instrument default settings

Measurement parameter	Item	Selection item/Setting range	Default values
Common	Auto hold	AS/AH	AS
	Temperature input value	0.0°C to 100.0°C	25.0°C
	Auto power off time	0 min to 30 min * <sup>1</sup>	30 min
	Auto data memory time	0, 2 s to 3600 s * <sup>2</sup>	0 s
	Auto data memory period	0 min to 3600 min	0 min
pH	Standard solution	USA/NIST/CUST	USA
	Calibration interval	0 day to 400 days * <sup>3</sup>	0 day
Conductivity	Cell constant	0.700 to 1.300 (0.1 cm <sup>-1</sup> , 1 cm <sup>-1</sup> , 10 cm <sup>-1</sup> )	1.000 (1 cm <sup>-1</sup> )
	Temperature coefficient	0.00%/°C to 10.00%/°C	2.00%/°C
	Unit	S/cm, S/m, mS/cm FIX	S/cm
	Calibration method	Auto/Manual	Auto
	Reference temperature	15°C to 30°C	25°C
Salinity	Unit	PPT, %	PPT
	Calculation method	NaCl/Sea water	NaCl
TDS	Calculation method	Linear/442/En27888/ NaCl	Linear

\*1: When 0 is inputted, auto power OFF is OFF.

\*2: When 0 is inputted, auto data memory is OFF.

\*3: When 0 is inputted, calibration alarm interval is OFF.

## ■ Technical note

### ● pH standard solutions at various temperatures

< USA >

Temp. (°C)	pH 2 Oxalate	pH 4 Phthalate	pH 7 Neutral phosphate	pH 10 Carbonate	pH 12 Saturated calcium hydroxide solution
0	1.666	4.003	7.119	10.318	13.423
5	1.668	3.999	7.086	10.245	13.207
10	1.670	3.998	7.058	10.178	13.003
15	1.672	3.999	7.035	10.117	12.810
20	1.675	4.002	7.015	10.061	12.627
25	1.679	4.008	7.000	10.011	12.454
30	1.683	4.015	6.988	9.965	12.289
35	1.688	4.024	6.979	9.925	12.133
40	1.694	4.035	6.973	9.888	11.984
45	1.700	4.047	6.969	9.856	11.841

< NIST (pH 2, 4, 12 are common) >

Temp. (°C)	pH 7 Neutral phosphate	pH 9 Borate
0	6.984	9.464
5	6.951	9.395
10	6.923	9.332
15	6.900	9.276
20	6.881	9.225
25	6.865	9.180
30	6.853	9.139
35	6.844	9.102
40	6.838	9.068
45	6.834	9.038

Tip

The differences between NIST and USA standard solutions are a different pH7 value, and the use of pH10 standard solution instead of pH9 standard solution in USA.

**Note**

Calibration is performed using Nernst's equation with the above values.

## ● Conductivity standard values at various temperatures

Temp. (°C)	Conductivity value at 25°C			
	84.00 (μS/cm)	1413 (μS/cm)	12.88 (mS/cm)	111.8 (mS/cm)
0	64.01	776	7.15	65.4
5	65.00	896	8.22	74.1
10	67.00	1020	9.33	83.2
15	68.00	1147	10.48	92.5
16	70.00	1173	10.72	94.4
17	71.00	1199	10.95	96.3
18	73.00	1225	11.19	98.2
19	74.00	1251	11.43	100.2
20	76.00	1278	11.67	102.1
21	78.00	1305	11.91	104.0
22	79.00	1332	12.15	105.9
23	81.00	1359	12.39	107.9
24	82.00	1386	12.64	109.8
25	84.00	1413	12.88	111.8
26	86.00	1440	13.13	113.8
27	87.00	1467	13.37	115.7
28	89.00	1494	13.62	117.7
29	90.00	1521	13.87	119.7
30	92.00	1548	14.12	121.8
31	94.00	1575	14.37	123.9

## Options

A wide variety of electrodes and options are available for use with the instrument. You can select the optimum electrode and options for your application and objectives.

These options can be purchased from your nearest agency. Please provide the part name and part number to the representative.

With regard to electrodes, it is important to select the optimum electrode for the sample you want to measure. For details, refer to the catalogue or our website, or contact your dealer.

Part name		Part number	Remarks
Plain paper printer	Printer (USA, 120 V)	3014030146	Printer cable sold separately
	Printer (EU, 230 V)	3014030147	
	Printer cable	3014030148	1.5 m
	Roll paper	3014030149	20 rolls/set
	Ink ribbon	3014030150	5 pcs/set
Serial cable		3014030151	1.5 m
AC adapter*		3200647413	With 6 plug adapters

\*: The AC adapter includes 6 plug adapters.  
Referring to the following table, attach the appropriate plug adapter to the AC adapter depending on the country to be used.

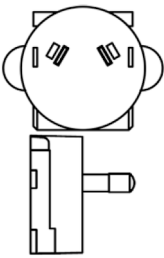
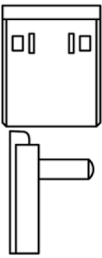
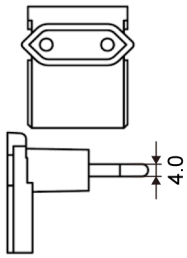
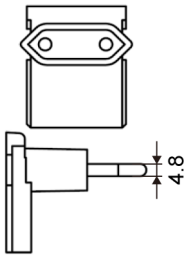
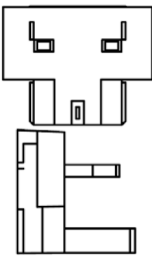
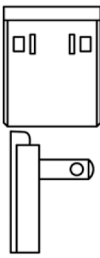
① Australia	② China	③ Europe	④ Korea	⑤ U.K., Singapore	⑥ USA, Canada, Taiwan
					



# **HORIBA** Advanced Techno

31, Miyanonishi-cho, Kisshoin Minami-ku, Kyoto 601-8306, Japan

<http://www.horiba-adt.jp>

---

For any questions regarding this product, please contact your local agency, or inquire from the following website.

[http://global.horiba.com/contact\\_e/index.htm](http://global.horiba.com/contact_e/index.htm)

---





