

HORIBA

Instruction Manual

Benchtop pH/ORP/Conductivity Meter

LAQUA-PH1500

LAQUA-EC1500

LAQUA-PC1500



LAQUA 1500

Benchtop pH/Water Quality Analyzer

■ Preface

This manual describes the operation of the following instrument.

Brand:	LAQUA
Series name:	LAQUA 1500 Series Benchtop Water Quality Meters
Model:	LAQUA-PH1500, LAQUA-EC1500, LAQUA-PC1500
Model description:	pH/ORP/Conductivity Benchtop Meter

Be sure to read this manual before using the product to ensure proper and safe operation of the product. Also, safely store the manual so, it is readily available whenever necessary. Product specifications and appearance, as well as the contents of this manual are subject to change without notice.

• Warranty and responsibility

HORIBA Advanced Techno Co., Ltd. warrants that the product shall be free from defects in material and workmanship and agrees to repair or replace free of charge, at option of HORIBA Advanced Techno Co., Ltd., any malfunctioned or damaged product attributable to responsibility of HORIBA Advanced Techno Co., Ltd. for a period of Three (3) years from the delivery unless otherwise agreed in a written statement. In any one of the following cases, none of the warranties set forth herein shall be extended:

- Any malfunction or damage attributable to improper operation
- Any malfunction attributable to repair or modification by any person not authorized by HORIBA Advanced Techno Co., Ltd.
- Any malfunction or damage attributable to the use in an environment not specified in this manual
- Any malfunction or damage attributable to violation of the instructions in this manual or operations in the manner not specified in this manual
- Any malfunction or damage attributable to any cause or causes beyond the reasonable control of HORIBA Advanced Techno Co., Ltd. such as natural disasters
- Any deterioration in appearance attributable to corrosion, rust and so on
- Replacement of consumables

HORIBA Advanced Techno Co., Ltd. SHALL NOT BE LIABLE FOR ANY DAMAGES RESULTING FROM ANY MALFUNCTIONS OF THE PRODUCT, ANY ERASURE OF DATA, OR ANY OTHER USES OF THE PRODUCT.

• Trademarks

- Microsoft, Windows, Windows Vista are registered trademarks or trademarks of Microsoft Corporation in the United States and other countries.
- Other company names and brand names are either registered trademarks or trademarks of the respective companies. (R), (TM) symbols may be omitted in this manual.

CODE:3200910464-GZ0000644511
May, 2021 © 2021 HORIBA Advanced Techno Co., Ltd.

Regulations

■ Regulations

• EU and UK Regulations

• Conformable Standards

This equipment conforms to the following standards:



EMC: EN61326-1
Class B, Basic electromagnetic environment
Safety: EN61010-1
RoHS: EN IEC 63000
9. Monitoring and control instruments including industrial monitoring and control instruments



EMC: BS EN 61326-1
Class B, Basic electromagnetic environment
Safety: BS EN 61010-1
RoHS: BS EN IEC 63000
9. Monitoring and control instruments including industrial monitoring and control instruments

Warning: This product is not intended for use in industrial environments. In an industrial environment, electromagnetic environmental effects may cause the incorrect performance of the product in which case the user may be required to take adequate measures.

• Installation Environment:

This product is designed for the following environment.

- Overvoltage category II
- Pollution degree 2
- Maximum operating altitude : 2000 m above sea level
- Range of application : For indoor use

Regulations

• Information on disposal of electrical and electronic equipment and disposal of batteries and accumulators

The crossed out wheeled bin symbol with underbar shown on the product or accompanying documents indicates the product requires appropriate treatment, collection and recycle for waste electrical and electronic equipment (WEEE) under the Directive 2012/19/EU, and/or waste batteries and accumulators under the Directive 2006/66/EC in the European Union. The symbol might be put with one of the chemical symbols below. In this case, it satisfies the requirements of the Directive 2006/66/EC for the object chemical. This product should not be disposed of unsorted household waste. Your correct disposal of WEEE, waste batteries and accumulators will contribute to reducing wasteful consumption of natural resources, and protecting human health and the environment from potential negative effects caused by hazardous substance in products.

Contact your supplier for information on applicable disposal methods.

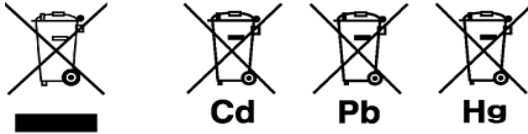

• Authorised representative in EU

HORIBA Europe GmbH
Hans-Mess-Str.6, D-61440
Oberursel, Germany

• Authorized Representative in UK

HORIBA UK Limited
Kyoto Close Moulton Park
NN3 6FL Northampton, UK
Tel: +44 01604 542500

• FCC rules

FCC Compliance Statement

This device complies with part 15 of the FCC Rules. Operation is subject to the following two conditions: (1) This device may not cause harmful interference, and (2) this device must accept any interference received, including interference that may cause undesired operation.

Responsible Party for FCC matter

HORIBA Instruments Incorporated
Head Office
9755 Research Drive
Irvine, California 92618 USA
+1 949 250 4811

Regulations

Note

This equipment has been tested and found to comply with the limits for a Class A digital device, pursuant to part 15 of the FCC Rules. These limits are designed to provide reasonable protection against harmful interference when the equipment is operated in a commercial environment. This equipment generates, uses, and can radiate radio frequency energy and, if not installed and used in accordance with the instruction manual, may cause harmful interference to radio communications. Operation of this equipment in a residential area is likely to cause harmful interference in which case the user will be required to correct the interference at his own expense.

Any changes or modifications not expressly approved by the party responsible for compliance could void the user's authority to operate the equipment.

• Korea certification

B급 기기 (가정용 방송통신기자재)

이 기기는 가정용(B 급) 전자파적합기기로서 주로 가정에서 사용하는 것을 목적으로 하며, 모든 지역에서 사용할 수 있습니다.

• China regulation

标记的意义

Meaning of Marking



本标记适用在中华人民共和国销售电器电子产品，标记中央的数字表示环境保护使用期限的年数。（不是表示产品质量保证期间。）只要遵守这个产品有关的安全和使用注意事项，从制造日开始算起在这个年限内，不会给环境污染、人体和财产带来严重的影响。请不要随意废弃本电器电子产品。

This marking is applied to electric and electronic products sold in the People's Republic of China. The figure at the center of the marking indicates the environmental protection use period in years. (It does not indicate a product guarantee period.) It guarantees that the product will not cause environment pollution nor serious influence on human body and property within the period of the indicated years which is counted from the date of manufacture as far as the safety and usage precautions for the product are observed. Do not throw away this product without any good reason.

产品中有害物质的名称及含量

Regulations

Name and amount of hazardous substance used in a product

部件名称 Unit name	有害物质 Hazardous substances					
	铅 Lead (Pb)	汞 Mer- cury (Hg)	镉 Cad- mium (Cd)	六价铬 Hexa- valent chromium (Cr (VI))	多溴联苯 Poly bromobi- phenyl (PBB)	多溴二苯醚 Poly bromo- diphenyl ether (PBDE)
本体 Main unit	×	○	○	○	○	○
AC 适配器 AC adapter ^{*1,*2}	×	○	○	○	○	○
电缆 Cable ^{*2}	×	○	○	○	○	○
支架 Stand ^{*2}	○	○	○	○	○	○
打印机 Printer ^{*2}	×	○	○	○	○	○
电极 Electrode ^{*2}	×	○	×	○	○	○

本表格依据 SJ/T 11364 的规定编制。

This form is prepared in accordance with SJ/T 11364.

○：表示该有害物质在该部件所有均质材料中的含量均在 GB/T 26572 规定的限量要求以下。

Denotes that the amount of the hazardous substance contained in all of the homogeneous materials used in the component is below the limit on the acceptable amount stipulated in the GB/T 26572.

×：表示该有害物质至少在该部件的某一均质材料中的含量超出 GB/T 26572 规定的限量要求。

Denotes that the amount of the hazardous substance contained in any of the homogeneous materials used in the component is above the limit on the acceptable amount stipulated in the GB/T 26572.

*1: 本部件的环保使用期限为10年。 The environmental protection use period of this product is 10 years.

*2: 选配件 Optional products

For Your Safety

■ For Your Safety

• Hazard classification and warning symbols

Warning messages are described in the following manner. Read the messages and follow the instructions carefully.

• Hazard classification



This indicates an imminently hazardous situation which, if not avoided, will result in death or serious injury. This is to be limited to the most extreme situations.



This indicates a potentially hazardous situation which, if not avoided, could result in death or serious injury.



This indicates a potentially hazardous situation which, if not avoided, may result in minor or moderate injury. It may also be used to alert against unsafe practices.

• Warning symbols



Description of what should be done, or what should be followed.



Description of what should never be done, or what is prohibited.

For Your Safety

• [DEU] Sicherheitsinformation

Lesen Sie vor der Verwendung des Produkts unbedingt diese Anleitung, um den ordnungsgemäßen und sicheren Betrieb des Produkts zu gewährleisten. Bewahren Sie die Anleitung sicher auf, damit sie bei Bedarf jederzeit zur Hand ist. Die Inhalt dieser Anleitung können ohne Vorankündigung geändert werden.

• Installationsumgebung

Dieses Produkt ist nicht zum Gebrauch in industriellen Umgebungen, wie in EN61326-1 definiert, vorgesehen.

In einer industriellen Umgebung können die elektromagnetischen Störungen eventuell zu Produktfehlfunktionen führen. Um dieses Produkt unter solchen Umständen verwenden zu können, muss der Benutzer ggf. angemessene Maßnahmen ergreifen.

Das Produkt ist gemäß EN61010-1 für die folgende Umgebung vorgesehen.

- Überspannungskategorie II
- Verschmutzungsgrad 2

• [FRA] Informations de sécurité

Veillez à lire le présent manuel avant d'utiliser le produit de manière à garantir son utilisation correcte et sûre.

De même, rangez le manuel dans un lieu sûr de manière à pouvoir vous y reporter lorsque cela est nécessaire.

Le contenu du présent manuel peut être modifié sans notification préalable.

• Environnement d'installation

Ce produit n'est pas destinés à une utilisation dans des environnements industriels, tels que définis dans la norme EN61326-1.

Dans un environnement industriel, les interférences électromagnétiques peuvent entraîner un dysfonctionnement du produit. Pour utiliser le produit dans ce type d'environnements, l'utilisateur peut avoir à prendre des mesures appropriées.

Le produit est conçu pour l'environnement suivant, tel que défini dans la norme EN61010-1.

- Catégorie de surtension II
- Degré de pollution 2

• [ITA] Informazioni sulla sicurezza

Leggere attentamente questo manuale prima di utilizzare il prodotto al fine di utilizzarlo in modo sicuro e adeguato. Inoltre, conservare in un luogo sicuro il manuale per poterlo consultare se necessario.

Le contenuti di questo manuale sono soggetti a modifiche senza preavviso.

For Your Safety

• Ambiente di installazione

Questo prodotto non è stato progettato per essere utilizzato in ambienti industriali, secondo la norma EN61326-1.

In un ambiente industriale, le interferenze elettromagnetiche potrebbero causare un malfunzionamento del prodotto. Per utilizzare il prodotto in tali ambienti, all'utente potrebbe essere richiesto di adottare le contromisure necessarie.

Il prodotto è designato per il seguente ambiente, definito nello standard EN61010-1.

- Categoria di sovratensione II
- Livello di inquinamento 2

• [SWE] Säkerhetsinformation

Se till att du läser denna handbok innan du börjar använda produkten för en korrekt och säker användning av den. Spara sedan handboken på en säker och lättåtkomlig plats så att du kan konsultera den när så behövs.

Innehållet i denna handbok kan komma att ändras utan föregående meddelande därom.

• Installationsmiljö

Detta produkten är ej avsedda för användning i industriella miljöer enligt riktlinjerna i EN61326-1.

Om den används i industrimiljöer kan de elektromagnetiska störningarna orsaka tekniska fel hos produkten. Om produkten ska användas i sådana miljöer kan användaren behöva vidta lämpliga åtgärder för att lösa dessa problem.

Produkten är utformad för användning i följande miljöer, i enlighet med SS-EN 61010-1.

- Överspänningskategori II
- Föroreningsgrad 2

• [SPA] Información de seguridad

Asegúrese de leer este manual antes de utilizar el producto para garantizar un uso correcto y seguro del mismo. Asimismo, guarde de forma segura el manual para que esté disponible siempre que sea necesario.

El contenido de este manual están sujetos a cambios sin previo aviso.

• Entorno de instalación

Este producto está diseñado para su uso en entornos industriales, tal y como se define en EN61326-1.

En un entorno industrial, las interferencias electromagnéticas pueden provocar un funcionamiento

incorrecto del producto. Para usar el producto en tales entornos, el usuario debe tomar las medidas adecuadas.

El producto se ha diseñado para el siguiente entorno, definido en EN61010-1.

- Categoría de sobretensión II
- Nivel de contaminación 2

For Your Safety

• [POL] Informacje dotyczące bezpieczeństwa

Przed przystąpieniem do użytkowania tego produktu należy dokładnie zapoznać się z niniejszą instrukcją, aby zapewniona była prawidłowa i bezpieczna eksploatacja produktu. Instrukcję przechowywać w bezpiecznym miejscu, aby w razie potrzeby była zawsze dostępna.

Treść niniejszej instrukcji może ulec zmianie bez wcześniejszego powiadomienia.

• Środowisko instalacji

Ten produkt nie są przeznaczone do użytkowania w środowisku przemysłowym, zgodnie z definicją określoną w normie EN61326-1.

W środowisku przemysłowym zakłócenia elektromagnetyczne mogą powodować nieprawidłowe działanie produktów. Możliwe, że aby użytkować produkt w takich środowiskach, użytkownik będzie musiał podjąć stosowne środki zaradcze.

Produkt jest przeznaczony do użycia w poniższym środowisku zdefiniowanym w normie EN61010-1.

- Kategoria przepięciowa II
- Stopień zanieczyszczenia 2

• [NLD] Veiligheidsinformatie

Lees deze handleiding voordat u dit product gebruikt zodat u het op de juiste manier en veilig kunt gebruiken. Bewaar de handleiding goed zodat u hem wanneer nodig kunt raadplegen.

De inhoud van deze handleiding kunnen zonder voorafgaande kennisgeving worden gewijzigd.

• Installatieomgeving

Dit product is niet bedoeld voor gebruik in een industriële omgeving zoals gedefinieerd in EN 61326-1.

In een industriële omgeving kan de elektromagnetische interferentie de werking van dit product storen. Voor gebruik van het product in een dergelijke omgeving moet de gebruiker mogelijk maatregelen treffen om de storing te verhelpen.

Het product is ontworpen voor de volgende omgeving, gedefinieerd in EN 61010-1.

- Overspanningscategorie II
- Vervuilingsgraad 2

For Your Safety

• [JPN] 安全情報

ご使用になる前に、本書を必ずお読みください。お読みになった後は必要なときにすぐに取り出せるように大切に保管してください。

本書に記載されている内容は予告なく変更される場合があります。あらかじめご了承ください。

設置環境

本製品は、EN61326-1 で定義される工業環境で使用することを想定した製品ではありません。

工業環境においては、電磁妨害の影響を受ける可能性があり、その場合には使用者が適切な対策を講ずることが必要となることがあります。

本製品は、EN61010-1 で定義される以下の環境用に設計されています。

- 過電圧カテゴリー II
- 汚染度2

For Your Safety

• Safety precautions

This section provides precautions for using the product safely and correctly and to prevent injury and damage. The terms of DANGER, WARNING and CAUTION indicate the degree of immanency and hazardous situation. Read the precautions carefully as it contains important safety messages.

• Instrument and electrode



WARNING



Do not disassemble or modify the instrument. Otherwise, it may heat up or be ignited resulting in a fire or an accident.



CAUTION

Harmful chemicals

Some electrodes are used with hazardous standard solutions. Handle them with care. The internal solution of pH electrode is highly concentrated potassium chloride (3.33 mol/L KCl). If the internal solution comes in contact with the skin, wash it off immediately. If it gets into the eyes, flush with plenty of water and then consult a doctor.



Broken glass

Broken glass may cause injury. The outer tube and tip of an electrode are made of glass. Handle them with care.



Do not use the phono jack under wet or humid conditions. Otherwise, it may cause a fire, electric shock, or breakage.

Product Handling Information

■ Product Handling Information

• Operational Precautions (instrument)

- Only use the product including accessories for their intended purpose.
- Do not drop or physically impact the instrument.
- The instrument is made of solvent-resistant materials but that does not mean it is resistant to all chemicals. Do not expose the instrument in strong acid or alkali solution, or wipe with such solution.
- If the instrument is dropped into water or gets wet, wipe it using soft cloth. Do not heat to dry it.
- Use fingers to press the operation keys. Do not use a hard object like a metal stick or rod.
- Be careful not to let water inside the instrument. The instrument is not waterproof.
- To disconnect an electrode or serial cable, hold the connector and pull it off. If you pull at the cable, it may cause breakage.
- The phono jack communication between the instrument and a personal computer (referred to as PC in the rest of this document) may fail because of environmental conditions, such as electromagnetic noise.
- Do not use an object with a sharp end to press the keys.
- If the power supply is interrupted while measurement data is being saved in the instrument, the data could be corrupted.
- Make sure to use the provided power supply cable to power this product.

• Environmental conditions for use and storage

- Temperature: 0°C to 45°C
- Humidity: under 80% relative humidity and free from condensation

• Avoid the following conditions:

- Strong vibration
- Direct sunlight
- Corrosive gas environment
- Locations close to an air-conditioner
- Direct wind
- Dusty Environment

• Transportation

When transporting the instrument, repackage it in the original package box. Otherwise, it may cause instrument damage.

• Disposal

- Standard solution used for the calibration must be under neutralized before the disposal.
- When disposing of the product, follow the related laws and regulations of your country for disposal of the product.

Manual Information

■ Manual Information

- Description in this manual

Note

This interprets the necessary points for correct operation and notifies the important points for handling the product.

Tip

This indicates reference information.

Contents

■ Product Overview.....	1
● Package Content.....	1
● Key Features.....	2
■ Basic Operations.....	7
● Turning On the Instrument.....	7
● Connecting an Electrode.....	7
● Changing the Operation Mode.....	8
● Changing the Measurement Parameter.....	10
■ Calibration.....	11
● pH Calibration.....	11
● ORP/mV Calibration.....	13
● Conductivity Calibration.....	15
● TDS Calibration.....	18
● Salinity Calibration.....	19
● Temperature Calibration.....	21
■ Data.....	23
● Data Capture and Storage.....	23
● Data Transfer.....	24

Contents

■ Setup.....	25
● P1 pH Setup.....	25
● P1 COND Setup.....	29
● P2 TDS Setup.....	37
● P3 SAL Setup.....	41
● Data Setup.....	45
● General Setup.....	52
■ Maintenance and Storage.....	61
● Maintenance and Storage of the Instrument.....	61
● Maintenance and Storage of Electrodes.....	62
■ Error Messages and Troubleshooting.....	64
■ Appendix.....	68

■ Product Overview

The LAQUA1500 series benchtop meters are optimized for laboratory measurement that allow you to measure pH, ORP/mV, conductivity, resistivity, TDS, salinity, and temperature.

This section describes the package content, key features and product components of LAQUA1500 series benchtop meters.

● Package Content

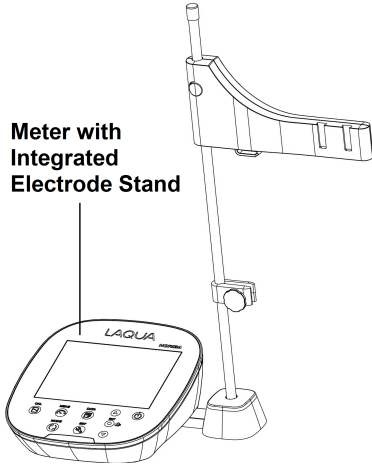

Meter with Integrated Electrode Stand

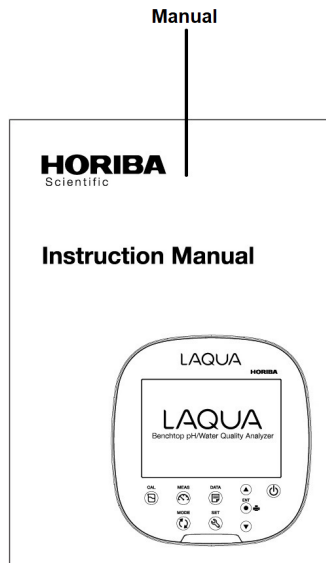

Manual

Universal Power Adapter with 6 Plugs

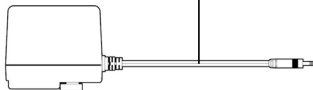

① Australia	② China	③ Europe	④ Korea	⑤ U.K., Singapore	⑥ USA, Canada, Taiwan

After opening the package, check for damage on the instrument and that the standard accessories all exist. If damage or defects are found on the product, contact your dealer.

● Key Features

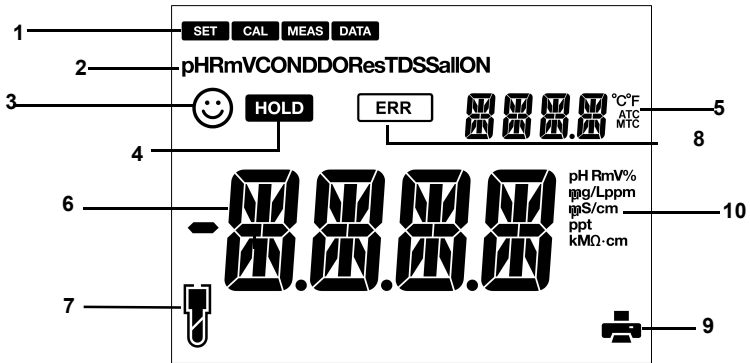

- Large monochrome LCD
- Integrated electrode holder (up to 2 electrodes) that can be attached to either side of the meter
- Simple user interface and single parameter display
- 1000 Memory data
- Automatic Temperature Compensation (ATC) with temperature calibration
- Adjustable auto shut-off time (1 to 30 minutes)
- Auto stable, auto hold, and real time measurement modes with reading stability indicators
- PC (standard USB) / printer (25 pin serial) connection via 2.5 mm diameter phono jack

● Display





No	Name	Function
1	Status Icon	Displays the current operation mode (Setup, Calibration, Measurement and Data mode)
2	Parameters	Displays the measured parameters like pH, mV, COND, Res, TDS, Sal
3		Smiley icon and sound indicate value is stable for documentation in Auto Stable and Auto Hold modes
4		Appears when the measured value display is stable and fixed in auto-hold mode
5	Temperature display area	Displays the measured temperature
6	Measured value, set item display area	Displays the measured value and the set value
7		Indicates electrode sensitivity level
8		Indicates error situation
9		Indicates data being transferred to the printer or computer
10	<p>pH RmV%</p> <p>mg/Lppm</p> <p>µS/cm</p> <p>ppt</p> <p>kMΩ·cm</p>	Displays the unit for the measurement parameter

● **pH Electrode Sensitivity Level**







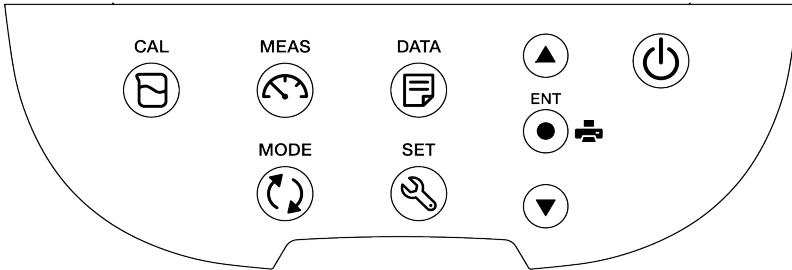

	Electrode sensitivity above 95% (excellent).
	Electrode sensitivity between 85% to 95% (very good).
	Electrode sensitivity between 80% to 85% (good). Refer "SLPE ERR" page 64

● **Conductivity Electrode Sensitivity Level**

	Calibration factor (C.F) between 0.90 to 1.11 (excellent).
	Calibration factor (C.F) between 0.80 to 1.25 (very good).
	Calibration factor (C.F) between 0.70 to 1.43 (good). Refer "SLPE ERR" on page 64

• Keypad Operation



Keypad	Name	Function
	CAL key	Switches from the measurement mode to the calibration mode. Starts calibration in the calibration mode.
	MEAS key	Switches from the operation mode to the measurement mode. Releases the fixed measurement value mode in the auto hold mode and begins a fresh measurement.
	DATA key	Switches from the measurement mode to the data mode.
	MODE key	In the measurement mode, changes measurement parameters.
	SET key	Switches from the measurement mode to the setup mode.
	ENTER key	Determines the selection or setup. Saves data in the measurement mode and calibration mode.
	UP key	In the setup mode, navigates between various setups. Selects preferred option in some setup screens.
	DOWN key	Increases or decreases selected digit when entering numbers.
	POWER key	Powers ON/OFF the instrument.



■ Basic Operations

This section describes the basic operations such as turning on the instrument, connecting an electrode, and changing the operation modes and measurement parameters of LAQUA 1500 series benchtop meters.

● Turning On the Instrument

1. Insert the AC adapter cable by fitting with the AC adapter jack.
2. Insert the AC adapter into the electrical socket.
3. Press the POWER key of the meter.

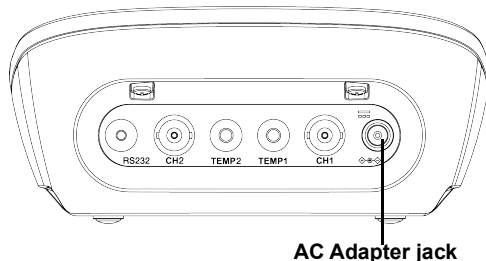

● Connecting an Electrode

To perform calibration / measurement, it is necessary to use the appropriate electrode for measurement parameter. Use the following procedure to correctly connect the electrode to the instrument:

1. Insert the electrode connector by fitting its groove with the connector pin of the instrument.
2. Turn the electrode connector clockwise by following the grooves.
3. Slide the connector cover on the connector.
4. When using a combination electrode equipped with a temperature sensor, insert the temperature jack (T) to the ATC socket on the meter.

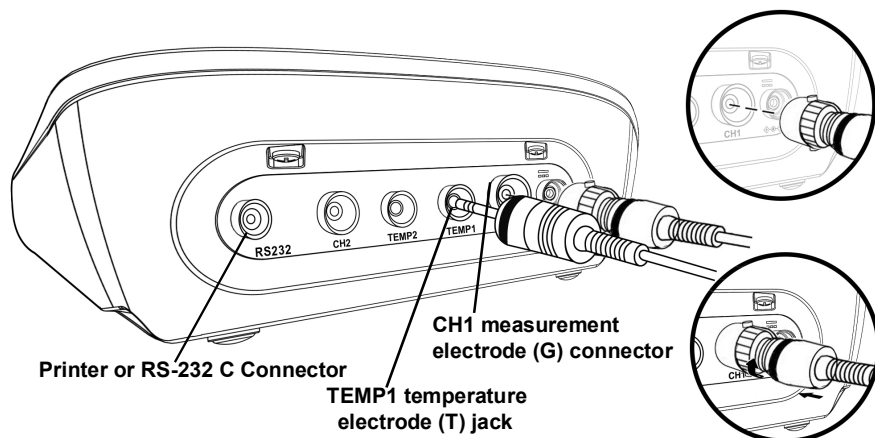

- **Changing the Operation Mode**

You can change the operation mode to four available modes depending on the purpose of use. The status icon indicates the current mode.

Status icon

SET





CAL

MEAS

DATA

Icon	Name	Function
MEAS	Measurement mode	Performs measurement.
CAL	Calibration mode	Performs calibration.
DATA	Data mode	Displays the saved data.
SET	Setup mode	Perform various setup functions.

You can change the operation mode using the corresponding key:

- **Measurement mode:** Press the  key to change to the measurement mode.
- **Calibration mode:** In the measurement mode, press the  key to change to the calibration mode.
- **Data mode:** In the measurement mode, press the  key to change to the data mode.
- **Setup mode:** In the measurement mode, press the  key to change to the setup mode.

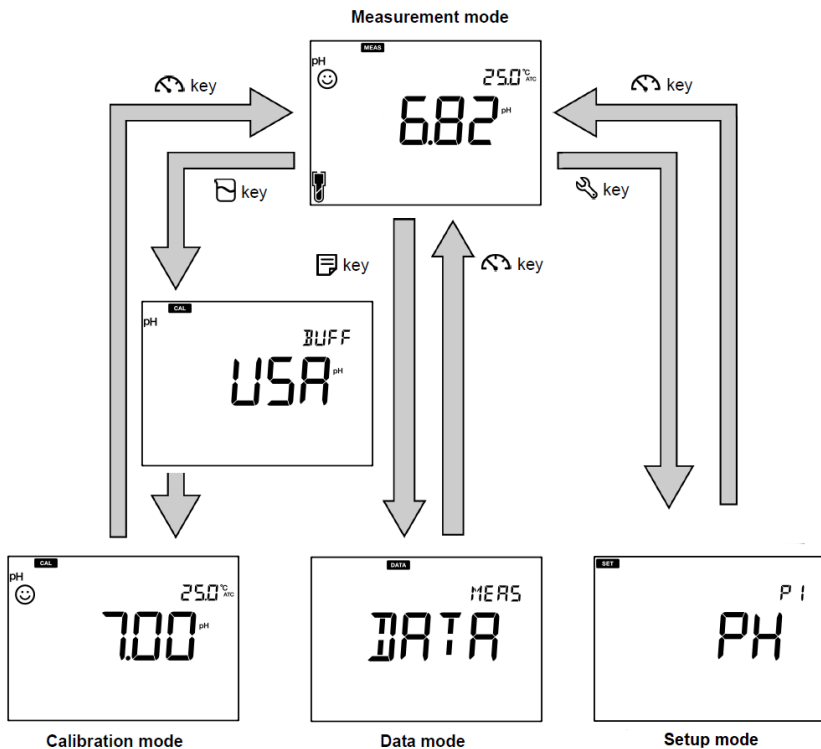

● **Changing the Measurement Parameter**

These instruments measure multiple parameters. For measurement, an electrode corresponding to the measurement parameter is required. In the measurement mode, the measurement parameter can be changed by pressing the  key.

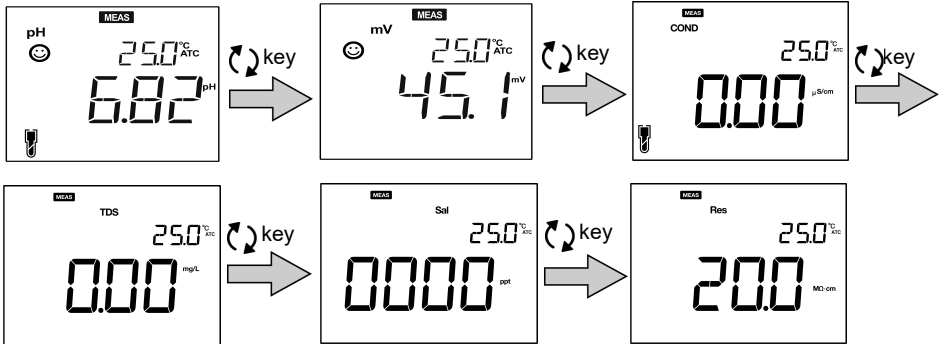

Model	Measurement Parameters
PH1500	pH, ORP / mV
EC1500	Conductivity, TDS, Salinity, Resistivity
PC1500	pH, ORP / mV, Conductivity, TDS, Salinity, Resistivity

■ Calibration

This section describes the calibration procedures using LAQUA 1500 series benchtop meters and electrodes.

● pH Calibration

Calibration is necessary for accurate pH measurement. To perform pH calibration using PH1500 and PC1500 benchtop meters, follow the procedure detailed below:

Prerequisites

- Clean the pH electrode with DI (deionized) water and wipe it with tissue paper.
- Switch on the meter and plug in the pH electrode.
- Prepare the buffers required for calibration.
- Keep the meter in pH measurement mode.
- Dip the pH electrode at least 3 cm in the buffer.





Note

- Perform two-point calibration using:
 - pH 7 and 4 for acidic sample.
 - pH 7 and 10 for alkaline sample.
 - Perform three-point calibration using pH 7, 4 and 10 if you are unsure of the expected sample pH value. It is recommended to calibrate with pH 7 first.
 - Default buffer setup is **BUFF USA**. If you want to change to **BUFF NIST** or **BUFF DIN**, refer to “P1.1 Buffer Setup” on page 26.
-

Tip

- To abort an ongoing calibration process at any point of time, press the  key.
 - It is recommended to clear the previous calibration data before performing calibration. For erasing the calibration data, refer to “P1.2 Erase Calibration Data” on page 27.
-

Calibration

1. After placing the pH electrode in the buffer solution, press the  key.
2. The selected buffer group appears on the meter screen and meter starts checking various calibration values with a blinking  on screen.
3. Wait for the  to stabilize (stable calibration reading). When it stabilizes, there will be a sound.
4. Press the **ENT**  key to confirm and save calibration data.
5. Meter displays **DONE** indicating end of the pH calibration procedure.
6. Repeat for other calibration points as required.

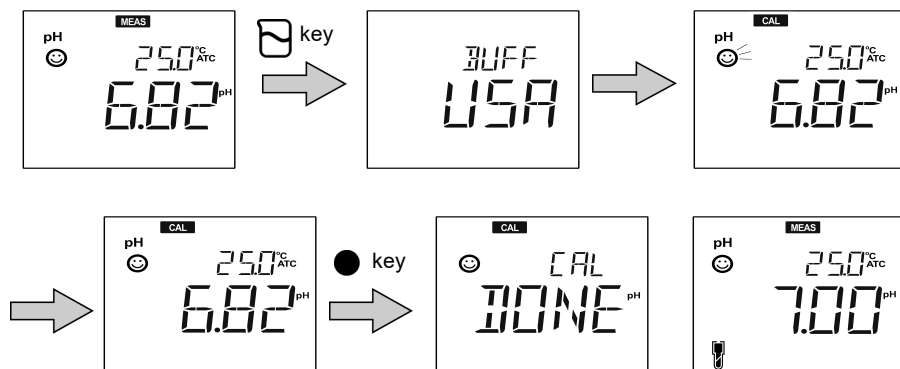

Note

To view and/or print calibration data, press the  key when you are in the **CAL** mode. The display scrolls through the calibrated values, offset, and slope (average slope for multi-point calibration).

• ORP/mV Calibration

Calibration is necessary for accurate ORP measurement. To perform ORP calibration using PH1500 and PC1500 benchtop meters, follow the procedure detailed below:

Prerequisites

- Clean the ORP electrode with DI (deionized) water and wipe it with tissue paper.
- Switch on the meter and plug in the ORP electrode.
- Prepare standard solution required for calibration.
- Ensure that the meter is in mV measurement mode.
- Dip the ORP electrode into the standard solution ensuring that the solution level is at least 3 cm from the electrode tip.







Note

- Absolute value measurement mode and relative value measurement mode are the two types of measurement mode available for ORP (mV) measurement.
 - In absolute value measurement mode, the handheld meter displays the actual voltage value.
 - In relative value measurement mode, user can adjust the absolute mV value by calibration. If the mV value is adjusted, the meter automatically indicates relative mV value as **RmV**. The adjustment mV is applied as an offset to the absolute mV value.
 - In the relative mV mode, the absolute mV value can be adjusted by ± 200 mV.
-

Tip

To abort an ongoing calibration process at any point of time, press the  key.

Calibration

1. After placing the electrode in the solution, press the  key to switch to mV mode.
2. Press the  key.
3. Meter starts reading mV values and the  blinks until value stabilizes.
4. Wait for the  to stabilize (stable calibration reading). When it stabilizes, there will be a sound.
5. Use the   keys to adjust the mV value to your desired value.
6. Press the **ENT**  key to confirm and save calibration data.
7. Meter displays **DONE** that indicates end of the ORP/mV calibration procedure.

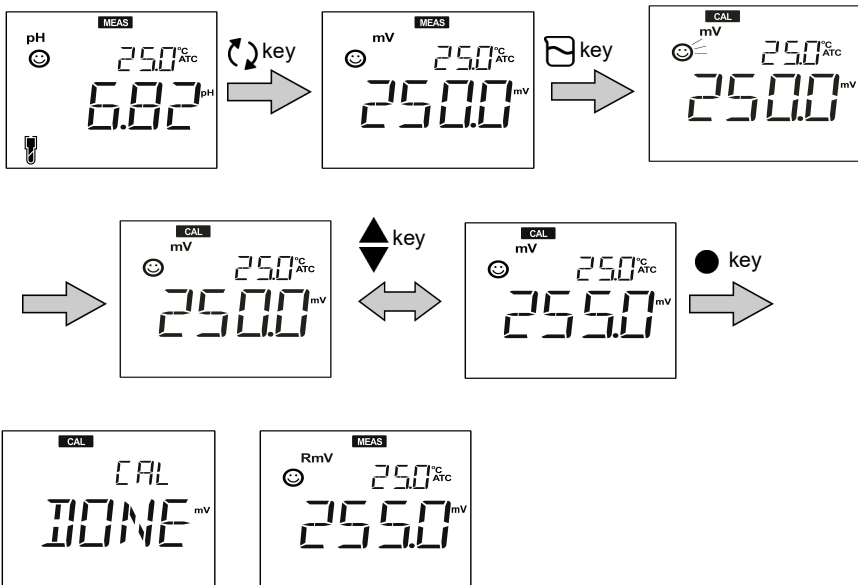

● Conductivity Calibration

Calibration is necessary for accurate electrical conductivity measurement. To perform conductivity calibration using EC1500 and PC1500 benchtop meters, follow the procedure detailed below:

Prerequisites

- Clean the conductivity electrode with DI (deionized) water and wipe it with tissue paper.
- Switch on the meter and plug in the conductivity electrode.
- Prepare standard solution required for calibration.
- Press the  key to keep the meter in **COND** mode.
- Dip the conductivity electrode in the standard solution until the hole at the upper part of the electrode is immersed.





Note

- Salinity, TDS, and resistivity of a sample solution are calculated from the measured value of conductivity.
 - In conductivity calibration mode, the default calibration method is auto calibration. If you like to change it to manual calibration method, refer "P1.3 Calibration Mode Setup" on page 32.
-

Tip

- For second or multiple point calibration, clean the conductivity electrode with DI water and follow the same procedure.
 - If you are performing multiple point calibration, calibrate to the lowest conductivity first and then move to increasing conductivity values. This minimizes cross contamination.
 - To abort an ongoing calibration process at any point of time, press the .
-

Auto Conductivity Calibration



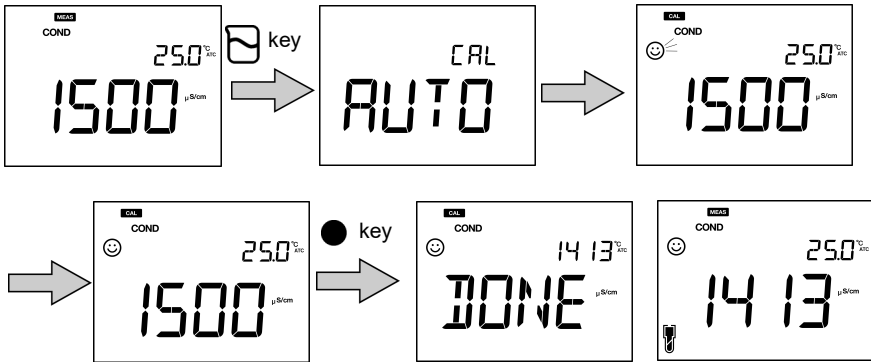



1. After placing the conductivity electrode in the standard solution, press the  key.
2. Meter displays “Auto cal” as per set calibration method and starts measuring various calibration values with a  blinking on screen.
3. Wait for the  to stabilize (stable calibration reading). When it stabilizes, there will be a sound.
4. Press the **ENT**  key to confirm and save calibration data.
5. Meter displays **DONE** indicating end of the conductivity calibration procedure.
6. Repeat for other calibration points as required.
7. You can calibrate one point for each range.



Note

To view and/or print calibration data, press the key  when you are in the CAL mode. The display scrolls through the calibrated values and calibration factor (average calibration factor for multi-point calibration).

Manual Conductivity Calibration

1. After placing the conductivity electrode in the standard solution, press the  key.
2. Meter displays "Manual cal" as per set calibration method and starts measuring various calibration values with a blinking  on screen.
3. Wait for the  to stabilize (stable calibration reading). When it stabilizes, there will be a sound.
4. Use the   keys to enter the electrical conductivity value of the standard solution used for calibration.
5. Press the **ENT**  key to confirm and save calibration data.
6. Meter displays **DONE** indicating end of the conductivity calibration procedure.
7. Repeat for other calibration points as required.
8. You can calibrate one point for each range.

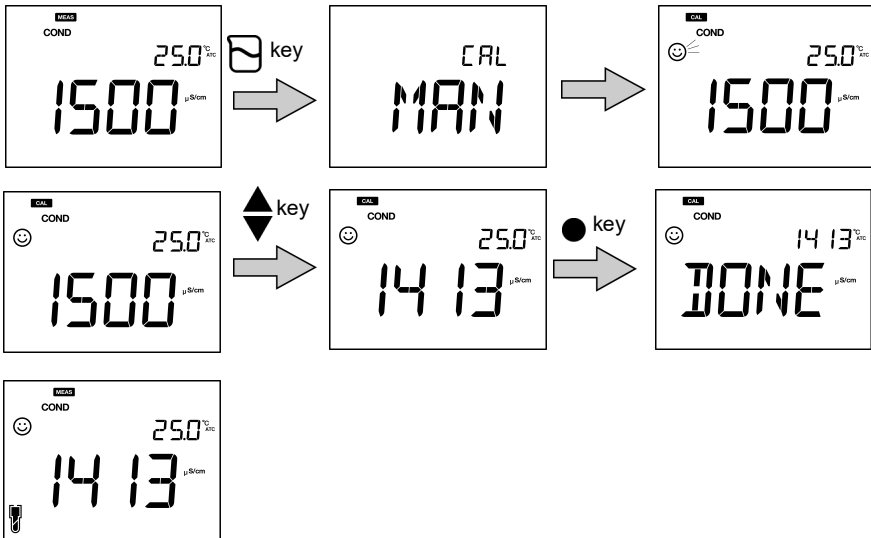

● TDS Calibration

Total dissolved solids (TDS) is calculated from the measured conductivity value so TDS calibration is not required. Once conductivity mode is calibrated, TDS values will be recalculated accordingly.

Set the appropriate TDS curve. Available TDS curves in the meter are as follows:

- **LINR** (Linear KCL curve with adjustable factor from 0.40 to 1.00)
- **442** (Myron L 442 non-linear curve)
- **EN** (European environmental standard non-linear curve)
- **NACL** (non-linear salinity curve)

Note

- To set a desired TDS method, refer "P2.1 TDS Curve Setup" on page 38.
-

• Salinity Calibration

Calibration is necessary for accurate salinity measurement. To perform salinity calibration using EC1500 and PC1500 benchtop meters, follow the procedure detailed below:

Prerequisites

- Clean the conductivity electrode with DI (deionized) water and wipe it with tissue paper.
- Switch on the meter and plug in the conductivity electrode.
- Prepare standard solution required for calibration.
- Press the  key to keep the meter in **SAL** mode.
- Dip the conductivity electrode in the standard solution until the hole at the upper part of the electrode is immersed.

Note

- Before salinity calibration, set the required salinity method. The available salinity methods are:

-**NACL**







-**SEA.W** (Sea water)

- To set a desired salinity method, refer "P3.2 Salinity Type Setup" on page 43.
 - User can adjust the salinity value by calibration.
-

Tip

To abort an ongoing calibration process at any point of time, press the  key.

Calibration

1. After placing the conductivity electrode in the standard solution, press the  key.
2. Meter starts measuring various calibration values with a  blinking on screen.
3. Wait for the  to stabilize (stable calibration reading). When it stabilizes, there will be a sound.
4. Use the   keys to adjust the salinity value.
5. Press the  **ENT** key to confirm and save calibration data.
6. Meter displays **DONE** indicating end of the salinity calibration procedure.

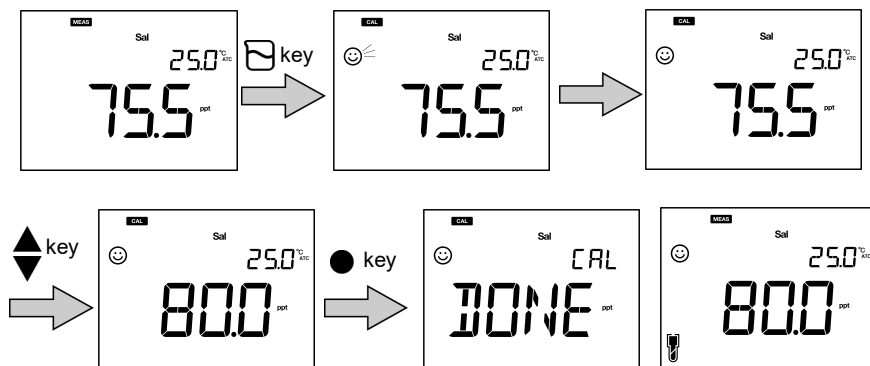

• Temperature Calibration

Temperature calibration is required to accurately match the electrode to the meter. Check the temperature reading and if it is acceptable, no temperature calibration is required. If you need to calibrate, please follow the procedure detailed below:

Prerequisites

- Clean the electrode with DI (deionized) water and wipe it with tissue paper.
- Switch on the meter and plug in the electrode and temperature sensor.
- Dip the electrode in standard solution until its temperature sensor is immersed.
- Wait for 5 minutes to ensure temperature stability.





Note

- Meter displays **MTC** if the temperature sensor is not plugged in and displays **ATC** if the temperature sensor is plugged in.
 - Temperature calibration must be performed using a known temperature solution or against a calibrated thermometer.
-

Tip

To abort an ongoing calibration process at any point of time, press the  key.

Calibration

1. After placing the electrode in the solution, press the  key.
2. Press the  key to switch to temperature calibration mode. Meter displays measured temperature value.
3. Use the   keys to adjust the temperature to the required value.
4. Press the **ENT**  key to save calibration data.
5. Meter displays **DONE** indicating end of the temperature calibration procedure.

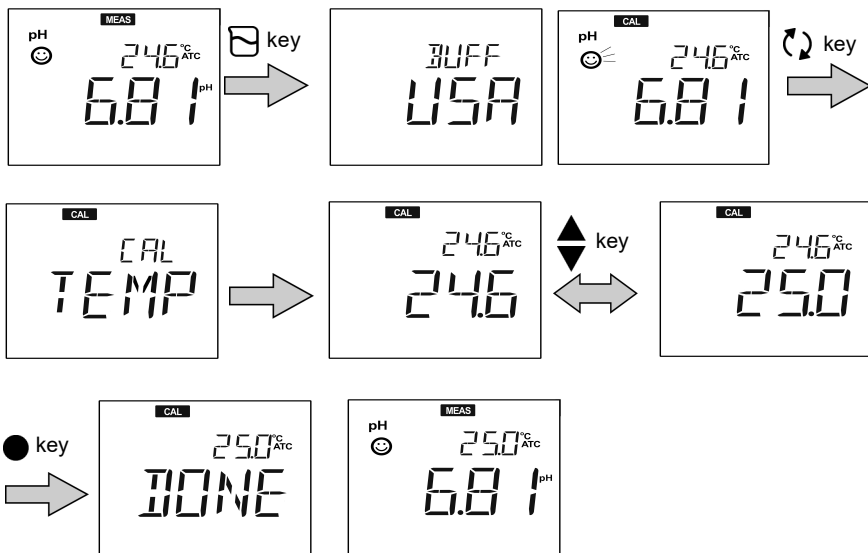

■ Data

This section describes the procedures for storing data into the LAQUA 1500 series benchtop meters and viewing them as well as transferring data from the meter to a PC.

● Data Capture and Storage

● Storing Data

Data measured by the instrument can be stored in the internal memory.

To save the measured data,



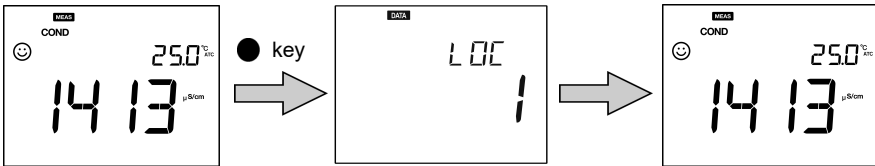

- Press the **ENT**  key to save the displayed data.
- Meter displays the location number of the saved data for 2 seconds and then the display returns to the previous screen automatically.



Note

- If the data storage limit reaches 1000, memory full error occurs and **MEM FULL** is displayed.
- In such case, print the data or transfer necessary data to a PC and delete the data from the internal memory of the instrument.

● Viewing Stored Data

- To view stored data, press  key.
- Use   keys to review different stored records.
- Press  key to return to measurement mode.

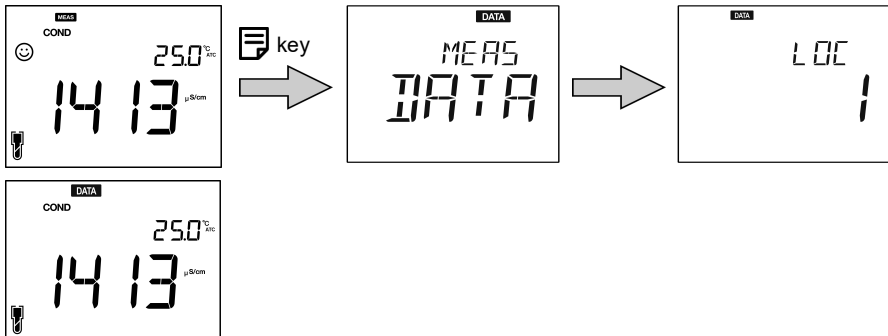





• Data Transfer

• Transferring Data to PC

Connect the instrument to a PC using the phono to USB cable and data acquisition software to transfer saved data to the PC. Connect the phono jack of the USB cable to the back of the instrument and the USB to the communication port of the PC.

• Printing Data

Connect the instrument to a printer using the phono to 25-pin d-sub printer cable and follow the procedure below to print a desired data set.

1. When in the measurement mode, press  key.
2. Use   keys to view desired stored data.
3. Press  key to print that individual data.

• Printer Format - Stored Data

Model	HORIBA PC1500
S/No	A91B1234
SW Rev	1.00
User Name	
Signature	
Logged Data	
Location	29
Mode	pH
pH	7.00 pH
mV	0.0 mV
Temp.	25.0 C (ATC)
Electrode	EXCELLENT

Tip

To print entire stored data log, refer "Print Data Log" on page 48.

■ Setup

This section describes all the setup functions available in LAQUA 1500 series benchtop meters.

● P1 pH Setup

Using P1 pH setup function of the meter, you can:

- Select buffer
- Erase calibration data

To set the pH functions using PH1500 and PC1500 benchtop meters, follow the procedure detailed below:

Prerequisites

- Switch on the meter.
- Press the  key to keep the meter in **pH** mode.







Note

- Default buffer setup is **BUFF USA**. You can change it to **BUFF NIST** or **BUFF DIN** if required.
 - Erasing previous calibration data is recommended for accurate calibration. Default setup is **NO** but to erase the calibration data, you need to change the setup to **YES**.
-

Tip





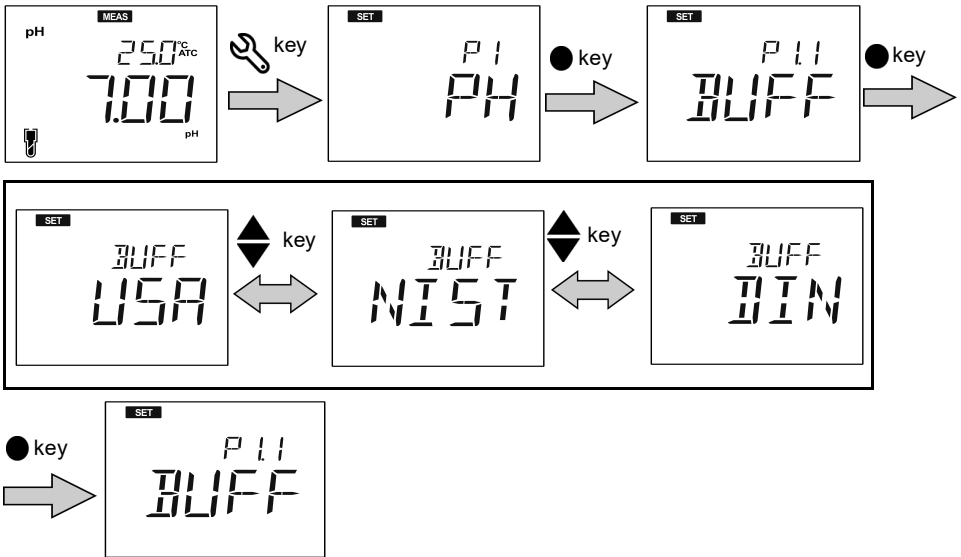

To return to the measurement mode, press the  key.

● **P1.1 Buffer Setup**

1. Press the  key, **P1 PH** screen appears.
2. Press the **ENT**  key, **P1.1 BUFF** screen appears.
3. Press the **ENT**  key, default **BUFF USA** appears.
4. Use the   keys to change the buffer group to **BUFF NIST** or **BUFF DIN**.
5. Press the **ENT**  key, **P1.1 BUFF** screen appears. This indicates completion of buffer selection.



• P1.2 Erase Calibration Data

1. Press the  key, **P1 PH** screen appears.
2. Press the **ENT**  key, **P1.1 BUFF** screen appears.
3. Press the  key, **P1.2 C.CLr** screen appears.
4. Press the **ENT**  key, default **CCLr NO** screen appears.
5. Use the   keys to change the setup to **YES**. This erases the calibration data.
6. Press the **ENT**  key, **P1.2 C.CLr** screen appears. This indicates erasure of calibration data.

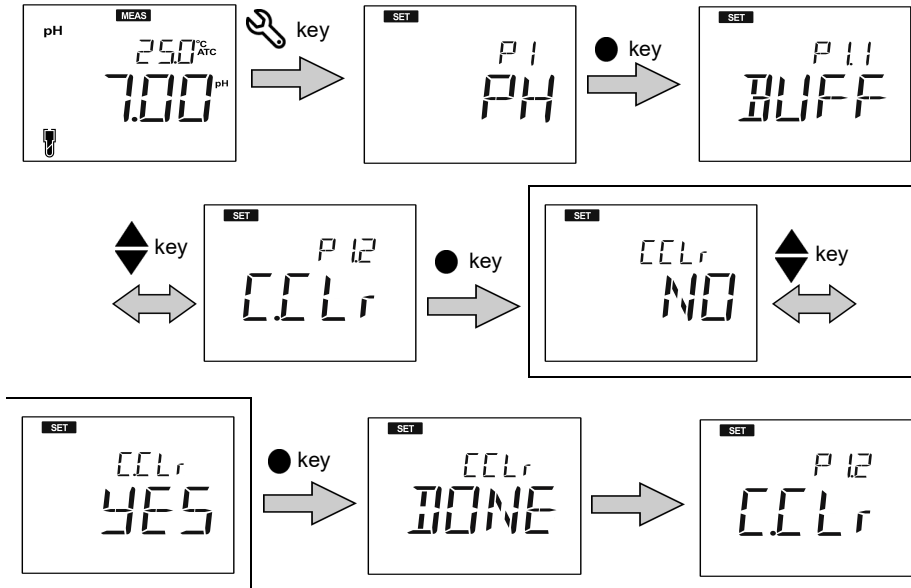

• P1 COND Setup

Using P1 COND setup function of the meter, you can:

- Set cell constant
- Select conductivity unit
- Set calibration mode
- Set temperature coefficient
- Set reference temperature
- Erase calibration data

To set the conductivity functions using EC1500 and PC1500 benchtop meters, follow the procedure detailed below:

Prerequisites

- Switch on the meter.
- Press the  key to keep the meter in **COND** mode.







Note

- Default cell constant value is **1.00** and one can set a value in between **0.07 to 13.00**.
 - Default conductivity unit is set as **S/cm**. One can change the unit to **S/m**.
 - Default auto calibration setup is set as **ON**, but to perform manual calibration, one need to change the setup to **OFF**.
 - Default temperature coefficient is **2.00%**. One can set a value in between **0.00% to 10.00%**.
 - Default reference temperature is **25.0°C**. One can set the value in between **15.0°C to 30.0°**.
 - Erasing previous calibration data is recommended for accurate calibration. Default setup is **NO** but to erase the calibration data, one need to change the setup to **YES**.
-

Tip





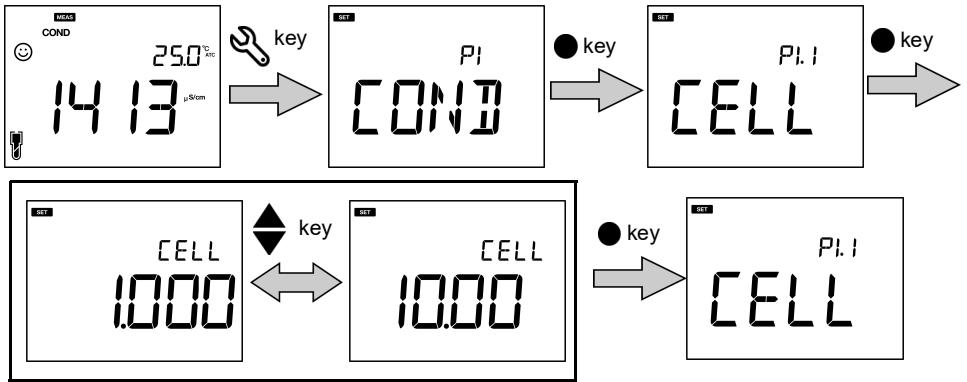

To return to the measurement mode, press the  key.

● **P1.1 Cell Constant Setup**

1. Press the  key, **P1 COND** screen appears.
2. Press the **ENT**  key, **P1.1 CELL** screen appears.
3. Press the **ENT**  key, default **CELL 1.00** appears.
4. Use the   keys to set the cell constant in between 0.07 to 13.00.
5. Press the **ENT**  key, **P1.1 CELL** screen appears. This indicates completion of cell constant setup.







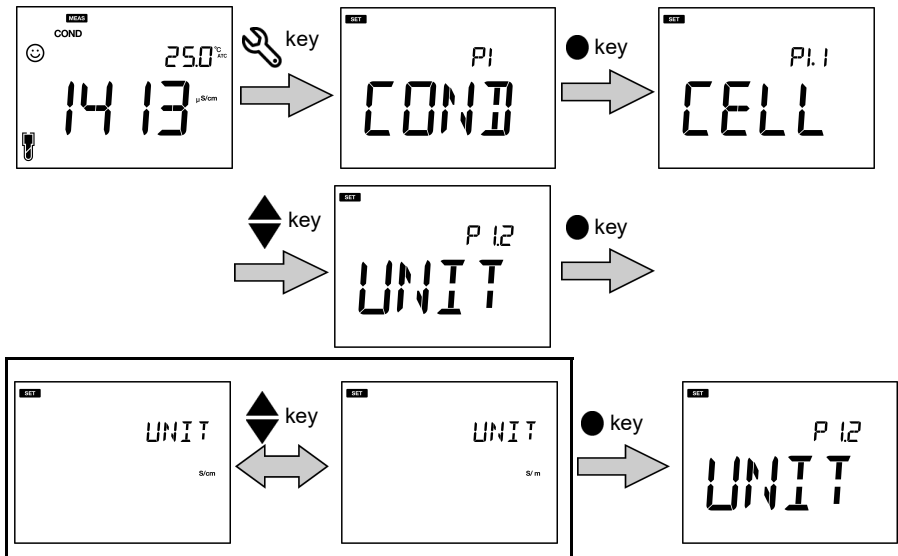



● **P1.2 Conductivity Unit Setup**

1. Press the  key, **P1 COND** screen appears.
2. Press the **ENT**  key, **P1.1 CELL** screen appears.
3. Press the  key, **P1.2 UNIT** screen appears.
4. Press the **ENT**  key, default **UNIT S/cm** appears.
5. Use the   keys to change the conductivity unit to S/m.
6. Press the **ENT**  key, **P1.2 UNIT** screen appears. This indicates completion of conductivity unit setup.







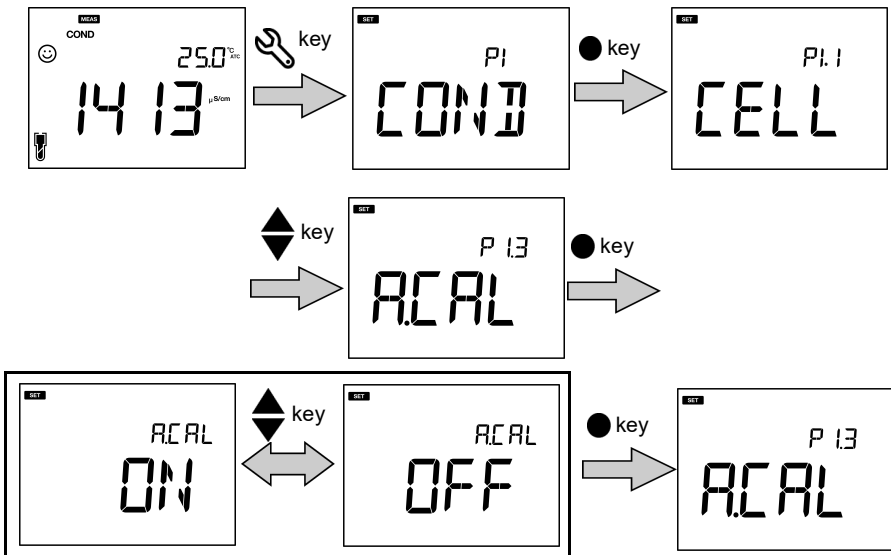



● **P1.3 Calibration Mode Setup**

1. Press the  key, **P1 COND** screen appears.
2. Press the **ENT**  key, **P1.1 CELL** screen appears.
3. Press the  key, **P1.2 UNIT** screen appears.
4. Press the  key, **P1.3 A.CAL** appears.
5. Press the **ENT**  key, default **ON** screen appears.
6. Use the   keys to change the set up to **OFF**. This enables the manual calibration mode.
7. Press the **ENT**  key, **P1.3 A.CAL** screen appears. This indicates completion of calibration mode setup.







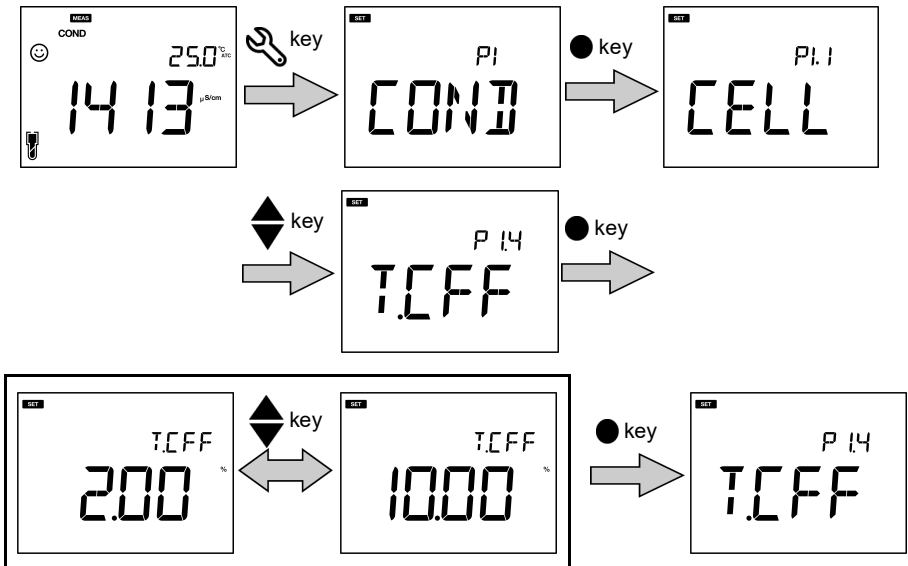





● **P1.4 Temperature Coefficient Setup**

1. Press the  key, **P1 COND** screen appears.
2. Press the **ENT**  key, **P1.1 CELL** screen appears.
3. Press the  key, **P1.2 UNIT** screen appears.
4. Press the  key, **P1.3 A.CAL** appears.
5. Press the  key, **P1.4 T.CFF** appears.
6. Press the **ENT**  key, default **2.00%** appears.
7. Use the   keys to set the temperature coefficient in between 0.00% to 10.00%.
8. Press the **ENT**  key, **P1.4 T.CFF** screen appears. This indicates completion of temperature coefficient setup.







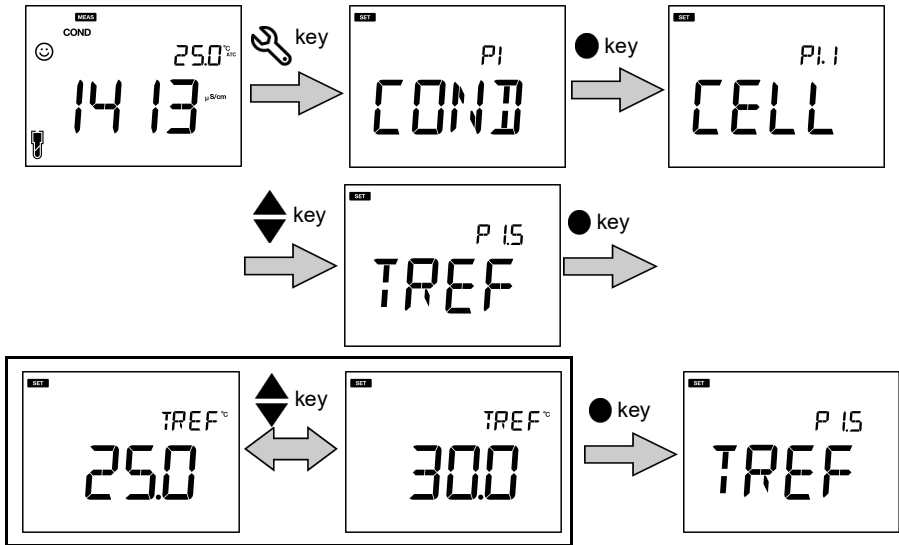





● **P1.5 Reference Temperature Setup**

1. Press the  key, **P1 COND** screen appears.
2. Press the **ENT**  key, **P1.1 CELL** screen appears.
3. Press the  key, **P1.2 UNIT** screen appears.
4. Press the  key, **P1.3 A.CAL** appears.
5. Press the  key, **P1.4 T.CFF** appears.
6. Press the  key, **P1.5 T.rEF** appears.
7. Press the **ENT**  key, default **25.0°C** appears.
8. Use the   keys to set the temperature coefficient in between 15.0°C to 30.0°C.
9. Press the **ENT**  key, **P1.5 T.rEF** screen appears. This indicates completion of reference temperature setup.



● **P1.6 Erase Calibration Data**

1. Press the  key, **P1 COND** screen appears.
2. Press the **ENT**  key, **P1.1 CELL** screen appears.
3. Press the  key, **P1.2 UNIT** screen appears.
4. Press the  key, **P1.3 A.CAL** appears.
5. Press the  key, **P1.4 T.CFF** appears.
6. Press the  key, **P1.5 T.rEF** appears.
7. Press the  key, **P1.6 C.CLr** appears.
8. Press the **ENT**  key, default **NO** screen appears.
9. Use the   keys to change the set up to **YES**. This erases the calibration data.
10. Press the **ENT**  key, **P1.6 C.CLr** screen appears. This indicates erasure of calibration data.

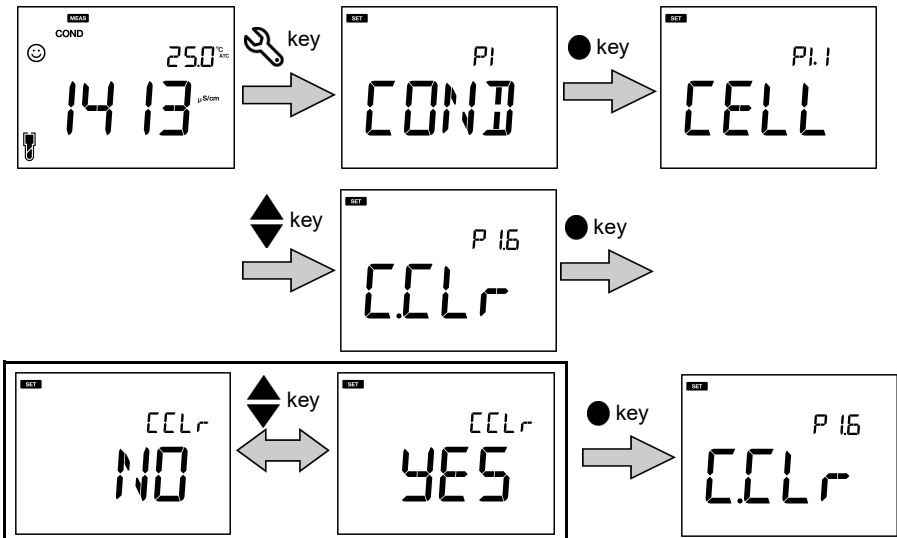

• P2 TDS Setup

Using P2 TDS setup function of the meter, you can:

- Select TDS curve
- Select TDS unit

To set the TDS functions using EC1500 and PC1500 benchtop meters, follow the procedure detailed below:

Prerequisites

- Switch on the meter.
- Press the  key to keep the meter in **COND** mode.







Note

- Default TDS curve is **linear**. You can change the TDS curve to 442 or EN27888 or NaCl.
 - For linear curve, default multiplier factor is **FACT 0.50**. You can set a multiplier factor in between 0.40 to 1.00.
 - Default TDS unit is set as **mg/L** (g/L). You can change the unit to ppm (ppt).
-

Tip

To return to the measurement mode, press the  key.

● **P2.1 TDS Curve Setup**



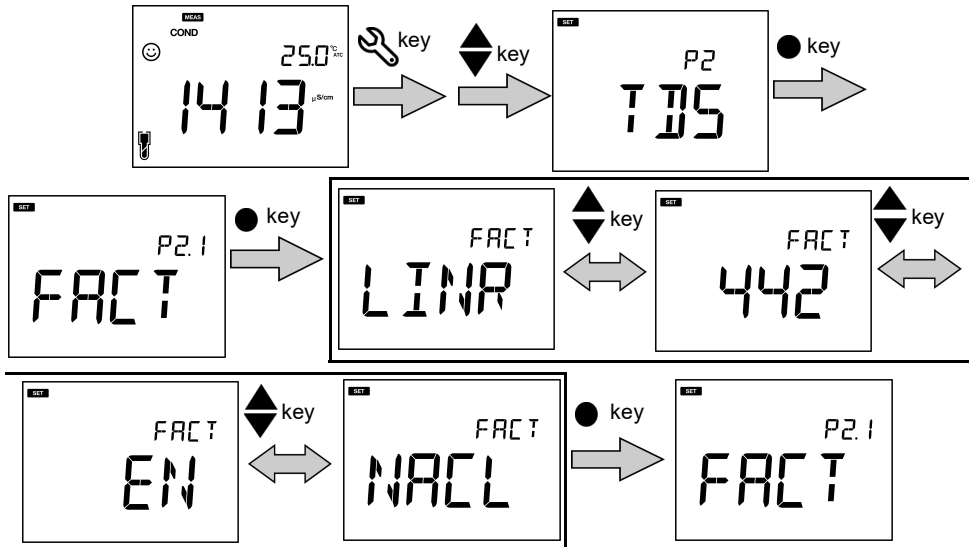



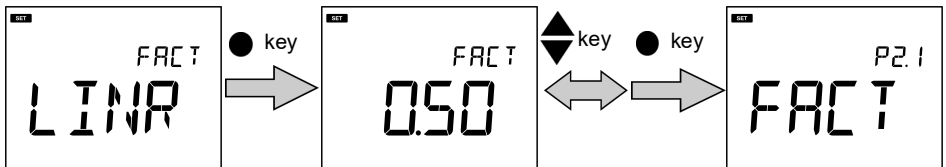

1. Press the  key, **P1 COND** screen appears.
2. Press the  key, **P2 TDS** screen appears
3. Press the **ENT**  key, **P2.1 FACT** screen appears.
4. Press the **ENT**  key, default **LINR** appears.
5. Use the   keys to select a TDS curve and press the **ENT** key.
6. While selecting the linear curve, set a factor in between 0.40 to 1.00 (default 0.50).
7. Press the **ENT**  key, **P2.1 FACT** screen appears. This indicates completion of TDS curve setup.



If you choose **LINR**, you can select a factor in between **0.40 to 1.00**.



• P2.2 TDS Unit Setup

1. Press the  key, **P1 COND** screen appears.
2. Press the  key, **P2 TDS** screen appears.
3. Press the **ENT**  key, **P2.1 FACT** screen appears.
4. Press the  key, **P2.2 UNIT** screen appears.
5. Press the **ENT**  key, default **mg/L (g/L)** appears
6. Use the   keys to change the TDS unit to ppm (ppt).
7. Press the **ENT**  key, **P2.2 UNIT** screen appears. This indicates completion of TDS unit selection.

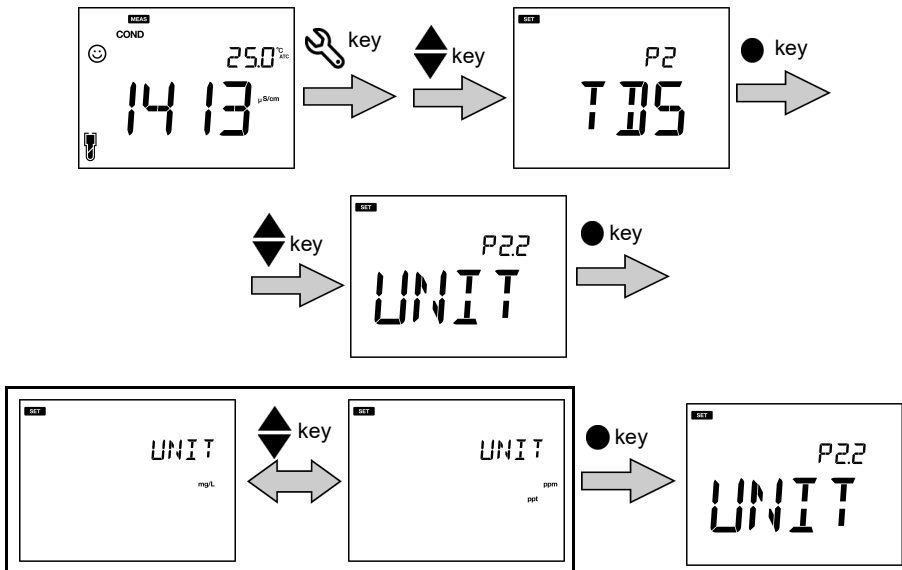

• P3 SAL Setup

Using P3 SAL setup function of the meter, you can:

- Select salinity unit
- Select salinity curve
- Erase calibration data

To set the salinity functions using EC1500 and PC1500 benchtop meters, follow the procedure detailed below:

Prerequisites

- Switch on the meter.
- Press the  key to keep the meter in **COND** mode.









Note

- Default salinity unit is set as **ppt**. You can change the unit to **percentage (%)**.
 - Default salinity type is set as **NaCl**. You can change the salinity type to seawater.
 - Erasing previous calibration data is recommended for accurate calibration. Default setup is **NO** but to erase the calibration data, you need to change the setup to **YES**.
-

Tip







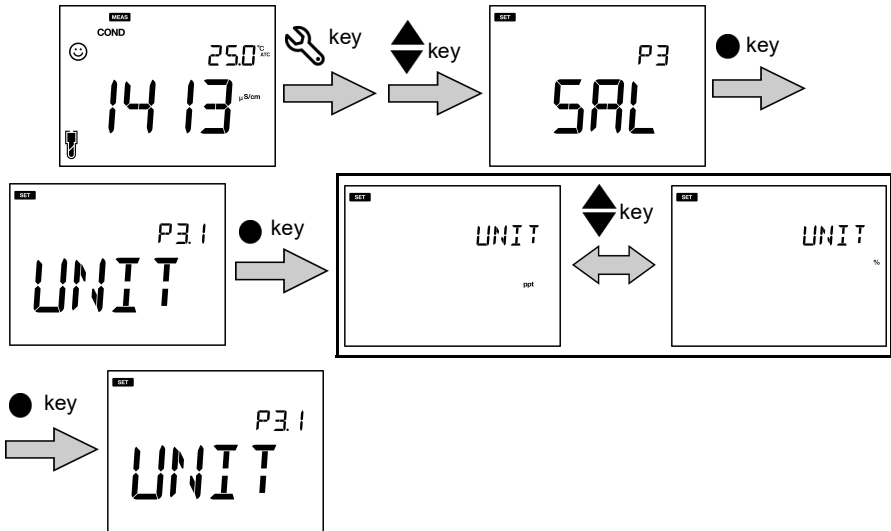

To return to the measurement mode, press the  key.

● **P3.1 Salinity Unit Setup**

1. Press the  key, **P1 COND** screen appears.
2. Press the  key, **P2 TDS** screen appears.
3. Press the  key, **P3 SAL** screen appears.
4. Press the **ENT**  key, **P3.1 UNIT** screen appears.
5. Press the **ENT**  key, default **ppt** appears.
6. Use the   keys to change the salinity unit to percentage (%).
7. Press the **ENT**  key, **P3.1 UNIT** screen appears. This indicates completion of salinity unit selection.







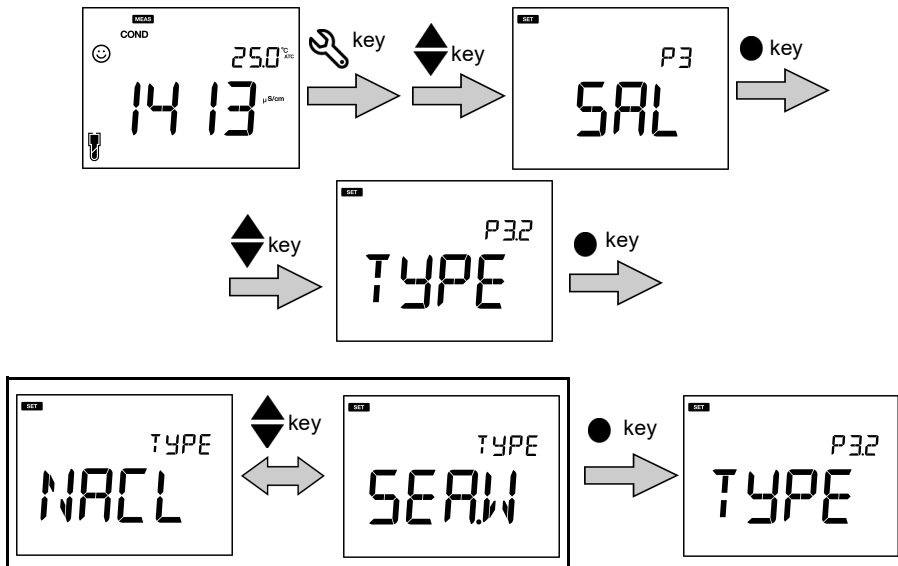





• P3.2 Salinity Type Setup

1. Press the  key, **P1 COND** screen appears.
2. Press the  key, **P2 TDS** screen appears.
3. Press the  key, **P3 SAL** screen appears.
4. Press the **ENT**  key, **P3.1 UNIT** screen appears.
5. Press the  key, **P3.2 TYPE** screen appears.
6. Press the **ENT**  key, default **NACL** appear.
7. Use the   keys to change the salinity type to seawater.
8. Press the **ENT**  key, **P3.2 TYPE** screen appears. This indicates completion of salinity type selection.



● **P3.3 Erase Calibration Data**

1. Press the  key, **P1 COND** screen appears.
2. Press the  key, **P2 TDS** screen appears.
3. Press the  key, **P3 SAL** screen appears.
4. Press the **ENT**  key, **P3.1 UNIT** screen appears.
5. Press the  key, **P3.2 TYPE** screen appears.
6. Press the  key, **P3.3 C.CLR** screen appears.
7. Press the **ENT**  key, default **NO** appears.
8. Use the   keys to change the set up to **YES**. This erases the calibration data.
9. Press the **ENT**  key, **P3.3 C.CLR** screen appears. This indicates erasure of calibration data.

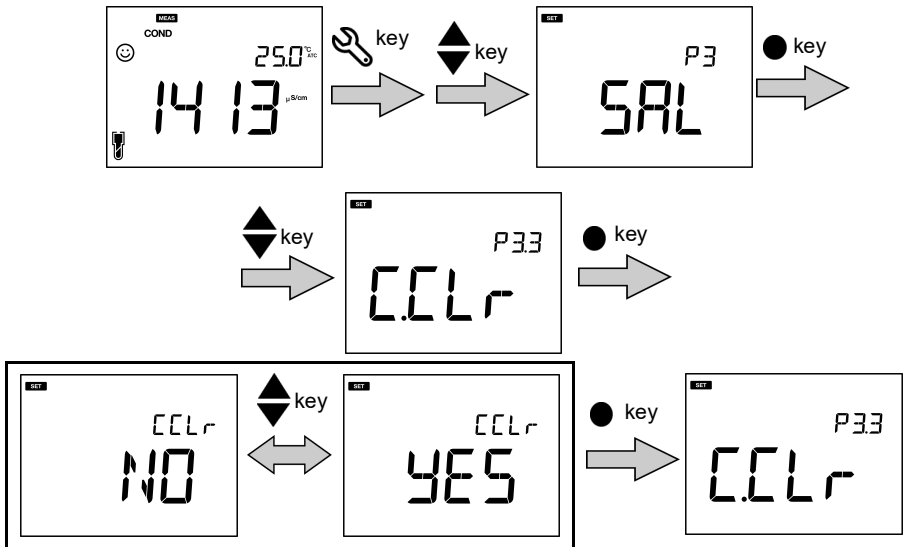

• Data Setup

Using Data setup function of LAQUA 1500 series benchtop meters, you can:

- Set data log interval
- Print data log
- Erase data log

To set the data functions, follow the procedure detailed below:

Prerequisites

- Switch on the meter.
- Keep the meter either in pH or conductivity mode (depending on the model).

Note







- Data set up procedure is common in both pH and EC mode with different meter screen display based on available set up sequence.
 - Default data log interval is "----" which indicates no data log interval has been set. Data log interval can be set from 2 to 999 seconds.
-

Tip

To return to the measurement mode, press the  key.

• Data Log Interval Setup

pH Mode

1. Press the  key, **P1 PH** screen appears.
2. Press the  key, **P2 DATA** screen appears.
3. Press the **ENT**  key, **P2.1 LOG** screen appears.
4. Press the **ENT**  key, default ---- log interval appears.
5. Use the   keys to set the data log interval.
6. Press the **ENT**  key, **P2.1 LOG** screen appears. This indicates completion of data log interval setup.

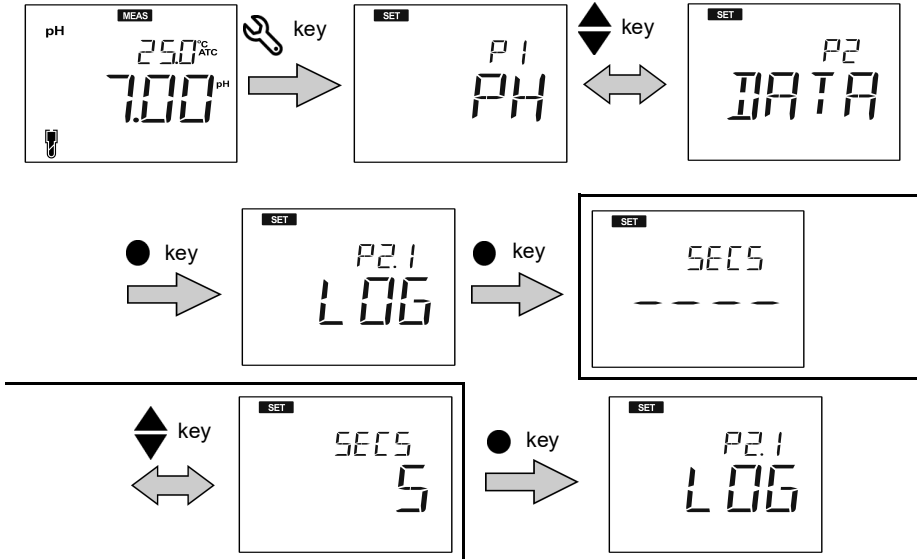



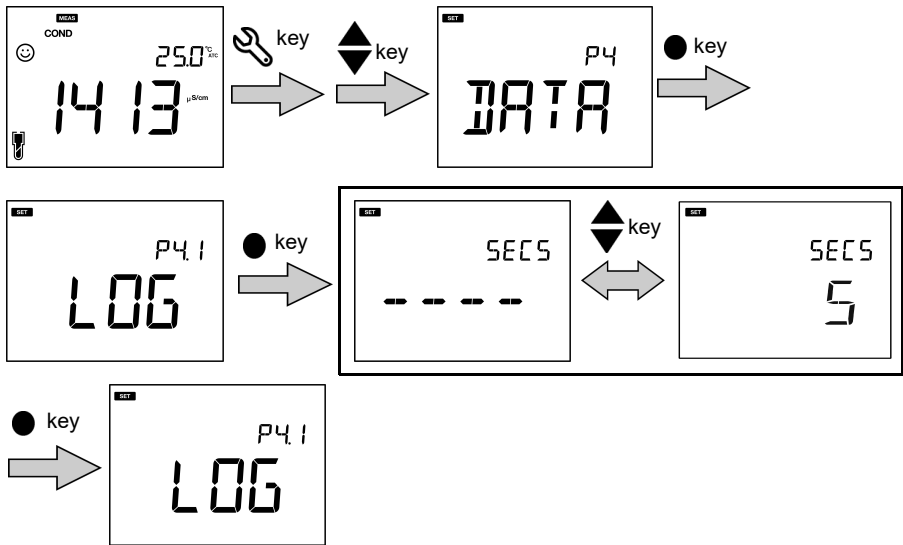





Conductivity Mode



• Print Data Log

pH Mode

1. Press the  key, **P1 PH** screen appears.
2. Press the  key, **P2 DATA** screen appears.
3. Press the **ENT**  key, **P2.1 LOG** screen appears.
4. Press the  key, **P2.2 PrNT** screen appears.
5. Press the **ENT**  key, default **NO** appears.
6. Use the   keys to change the setup to **YES**.
7. Press the **ENT**  key, **P2.2 PrNT** screen appears. This indicates completion of the print data log.

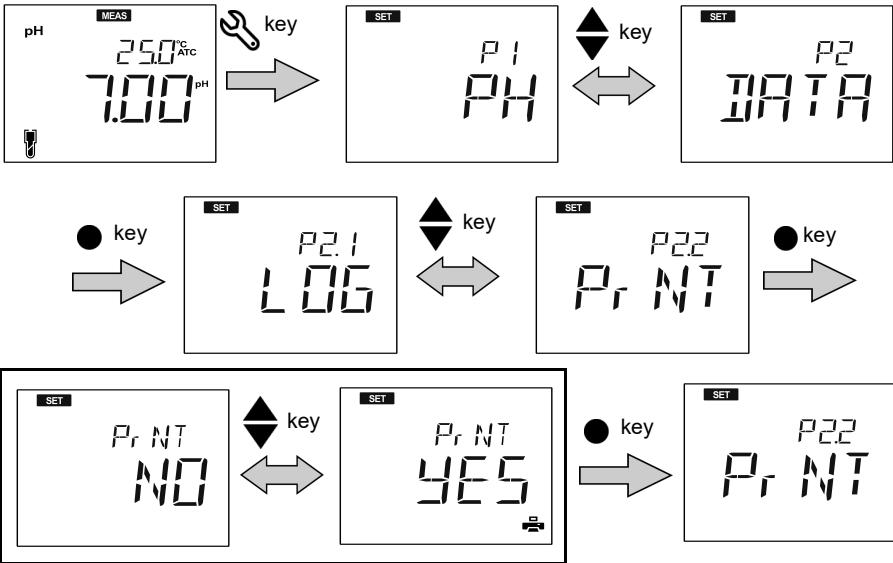

Tip





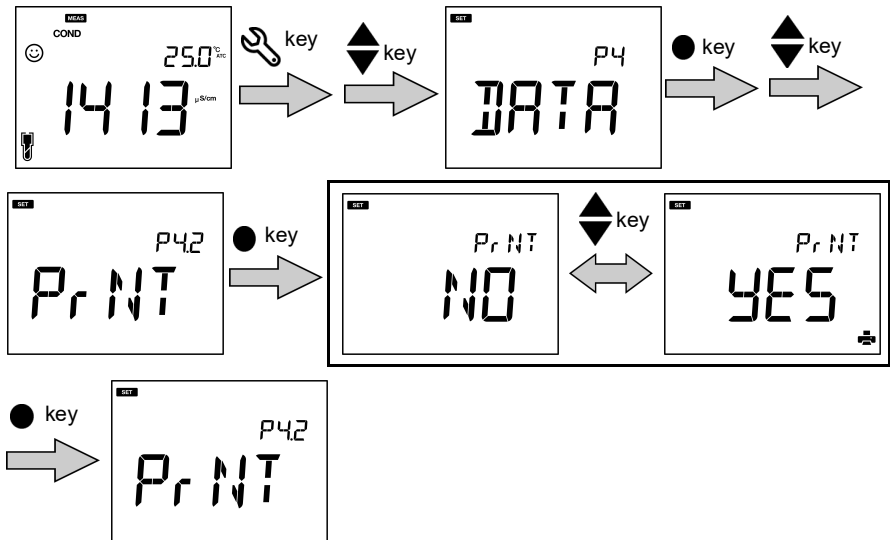



To stop the printing process, press and hold the  key.

Conductivity Mode



• Erase Data Log

pH Mode

1. Press the  key, **P1 PH** screen appears.
2. Press  key, **P2 DATA** screen appears.
3. Press the **ENT**  key, **P2.1 LOG** screen appears.
4. Press the  key, **P2.2 PRNT** screen appears.
5. Press the  key, **P2.3 D.CLR** screen appears.
6. Press the **ENT**  key, default **NO** appears
7. Use the   keys to set **YES** to erase all the data.
8. Press the **ENT**  key, **D.CLR DONE** screen appears briefly and then **P2.3 D.CLR** screen appears. This indicates completion of erasure of all data.

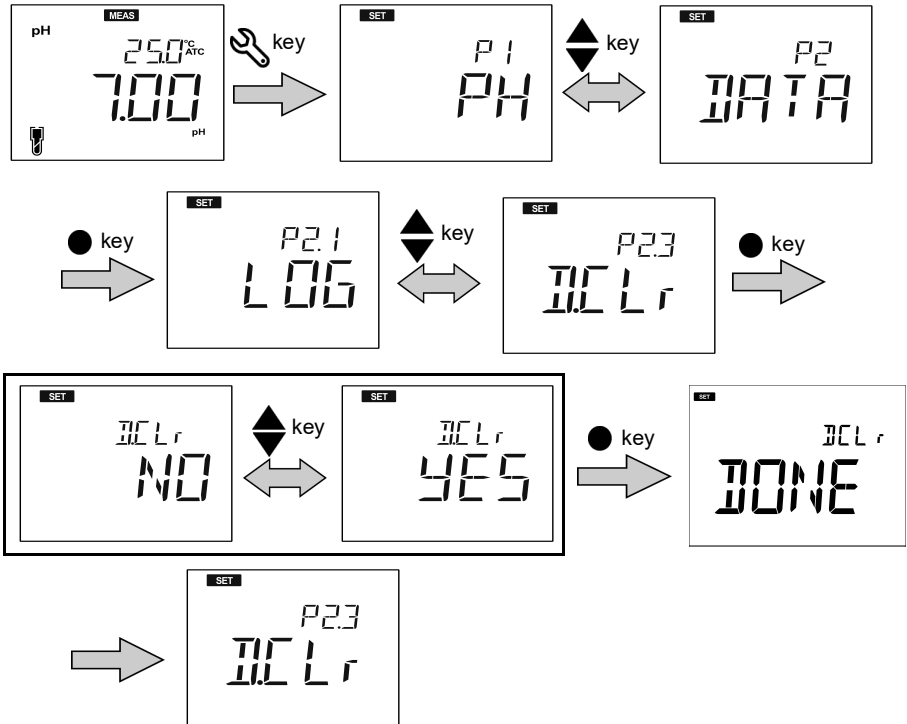

Conductivity Mode

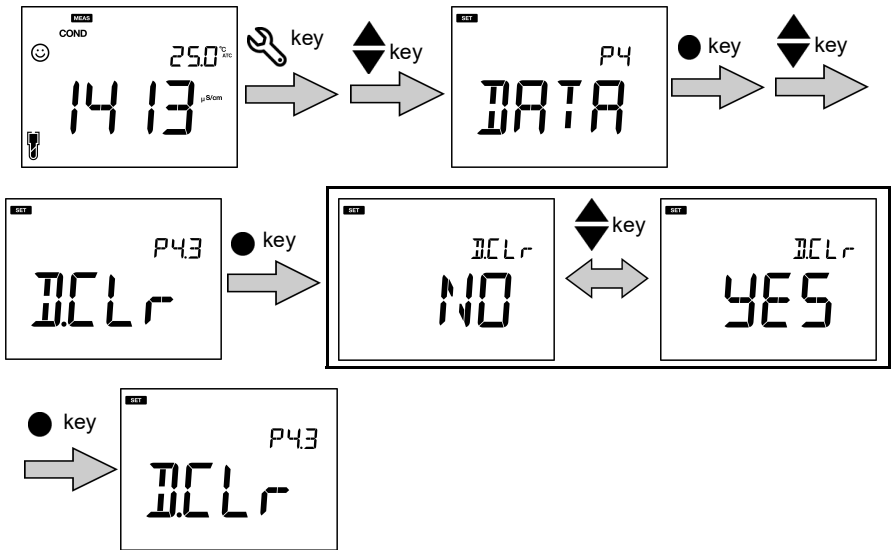

• General Setup

Using General setup function of the meter, you can:

- Select stability mode of the meter
- Set auto shut-off time
- Select temperature unit
- Reset the meter

To set the general functions, follow the procedure detailed below:

Prerequisites

- Switch on the meter.
- Keep the meter either in pH or conductivity mode (depending on the model).

Note

- General setup procedure is common in both pH and EC mode with different meter screen display based on available set up sequence.
 - In the calibration mode, the auto stable (**AS**) mode is activated. Default stability setup in measurement mode is “auto stable” (**AS**). If you like, you can change it to “auto hold” (**AH**) or “real time” (**RT**).
 - Default auto shut-off time is 30 minutes. You can set the time from ---- to 30 minutes, where ---- indicates “no auto shut-off time” has been set and meter will be “on” continuously.
 - Default temperature unit is °C and you can change the unit to °F.
 - Default reset meter setup is **NO**. If you like to reset the meter, you can change it to **YES**.
-

Tip

- Stability judgment criteria remains same for both auto stability mode and auto hold mode.
 - To return to the measurement mode, press the  key.
-









● **Auto Stable, Auto Hold and Real Time Mode Setup**

Auto Stable (AS) Mode – The meter shows live readings 😊 annunciator blinks until reading is stable.

Auto Hold (AH) Mode – The meter locks the stable reading; annunciator blinks until reading is stable and then **HOLD** lights up.

Real Time (RT) Mode – The meter shows live readings; both 😊 and **HOLD** annunciators are inactivate.

pH Mode

1. Press the  key, **P1 PH** screen appears.
2. Press  key, **P2 DATA** screen appears.
3. Press  key, **P3 GEN** screen appears.
4. Press the **ENT**  key, **P3.1 STBL** screen appears.
5. Press the **ENT**  key, the default **AS** (auto stable) stability mode appears.
6. Use the   keys to change the stability mode to **AH** (auto hold) or **RT** (real time).
7. Press the **ENT**  key, **P3.1 STBL** screen appears. This indicates completion of the stability mode selection.

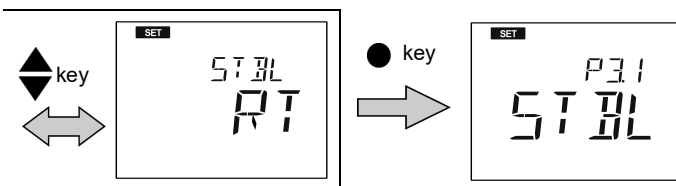
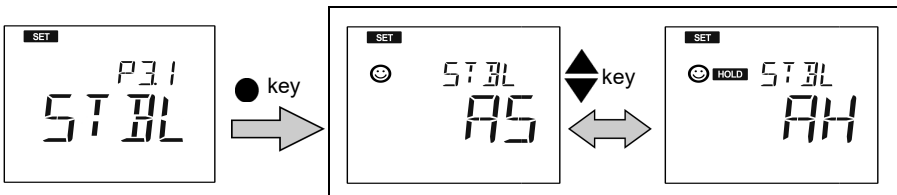
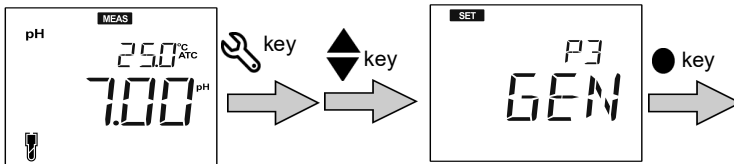



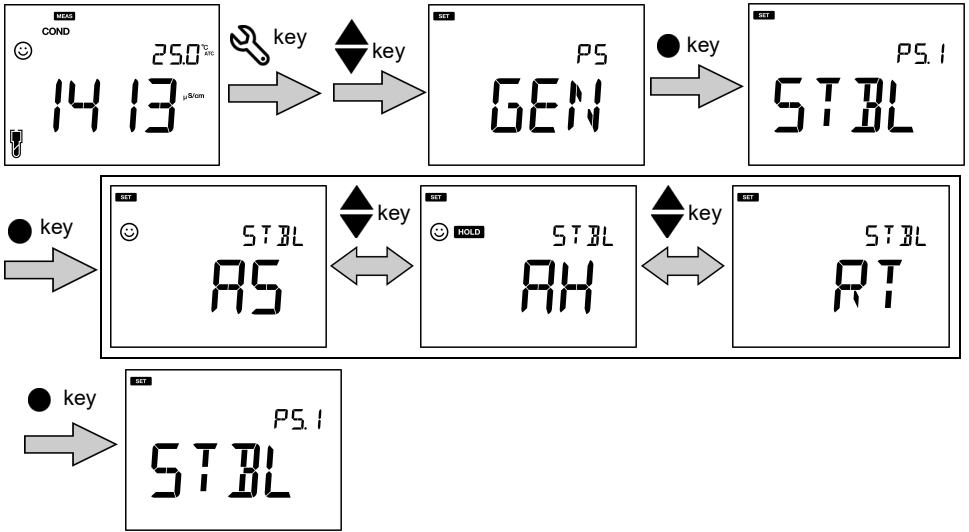





Conductivity Mode



• Auto Shut-off Time Setup

pH Mode

1. Press the  key, **P1 PH** screen appears.
2. Press the  key, **P2 DATA** screen appears.
3. Press the  key, **P3 GEN** screen appears.
4. Press the **ENT**  key, **P3.1 STBL** screen appears.
5. Press the  key, **P3.2 A.OFF** screen appears.
6. Press the **ENT**  key, default auto shut-off time **30 minutes** appear.
7. Use the   keys to adjust the auto shut-off time.
8. Press the **ENT**  key, **P3.2 A.OFF** screen appears. This indicates completion of the auto shut-off time setup.

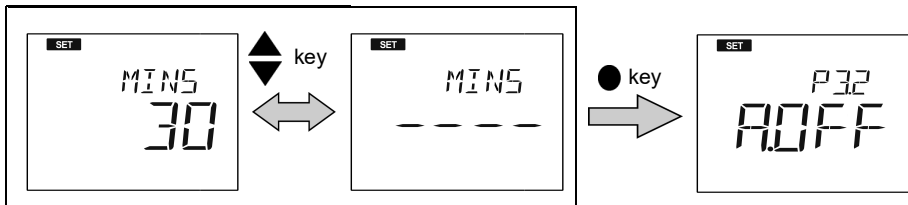
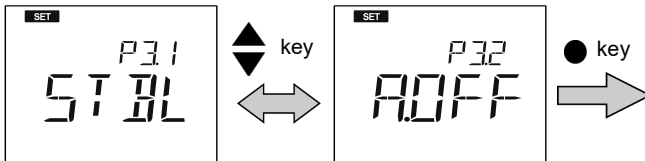
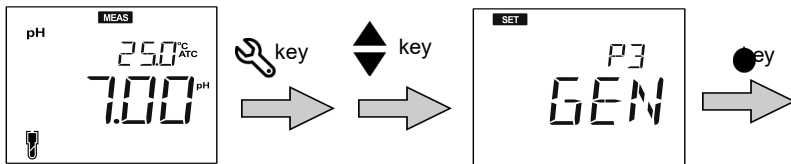



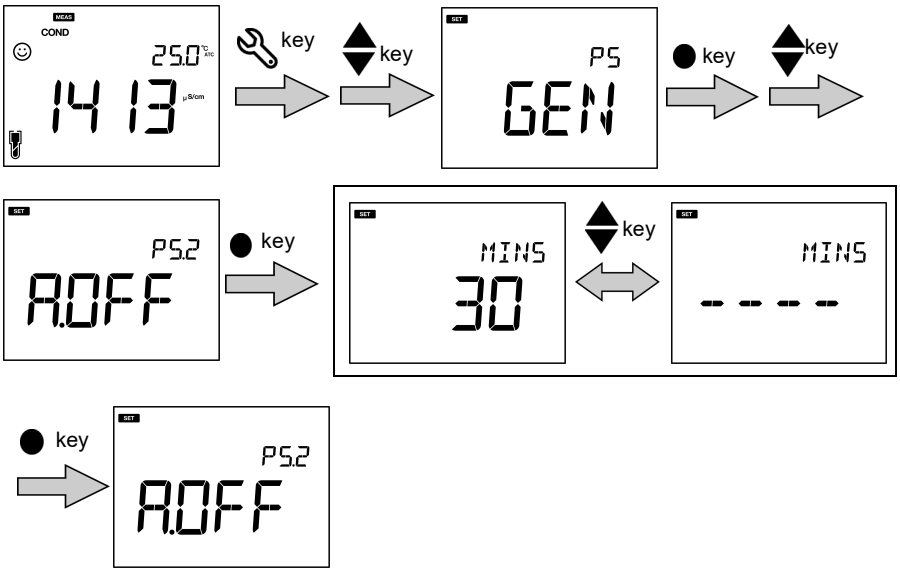







Conductivity Mode



• Temperature Unit Setup

pH Mode

1. Press the  key, **P1 PH** screen appears.
2. Press the  key, **P2 DATA** screen appears.
3. Press the  key, **P3 GEN** screen appears.
4. Press the  key, **P3.1 STBL** screen appears.
5. Press the  key, **P3.2 A.OFF** screen appears.
6. Press the  key, **P3.3°C°F** screen appears.
7. Press the **ENT**  key, default temperature unit °C appears.
8. Use the   keys to change the unit to °F.
9. Press the **ENT**  key, **P3.3°C°F** screen appears. This indicates completion of the end temperature unit selection.

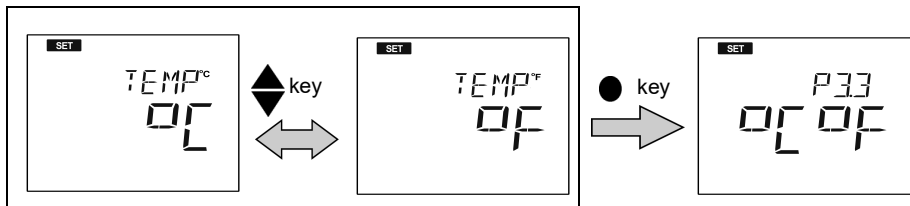
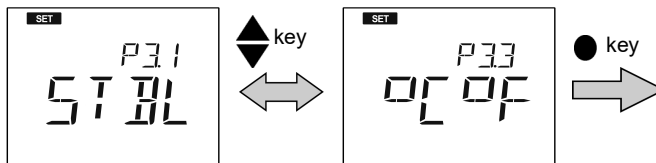
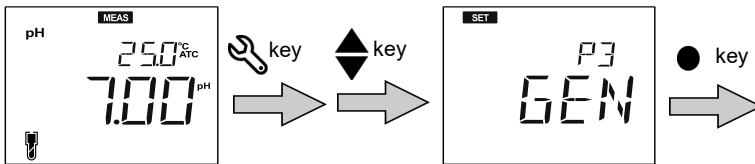



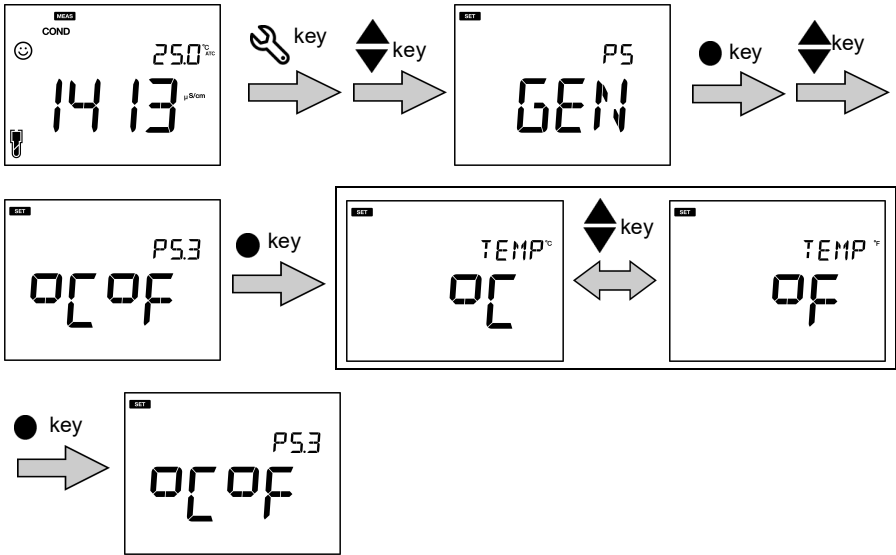







Conductivity Mode



• **Reset Meter**

pH Mode

1. Press the  key, **P1 PH** screen appears.
2. Press the  key, **P2 DATA** screen appears.
3. Press the  key, **P3 GEN** screen appears.
4. Press the **ENT**  key, **P3.1 STBL** screen appears.
5. Press the  key, **P3.2 A.OFF** screen appears.
6. Press the  key, **P3.3 °C°F** screen appears.
7. Press the  key, **P3.4 r.SET** screen appears.
8. Press the **ENT**  key, default reset meter setup **NO** appears.
9. Use the   key to set it **YES**.
10. Press the  key, meter displays **DONE** and automatically switches off.

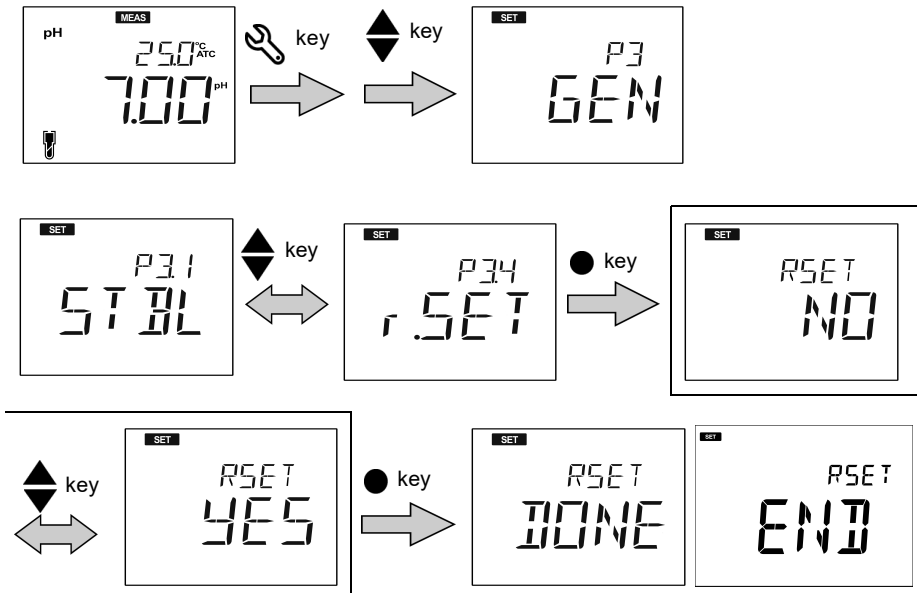

Conductivity Mode

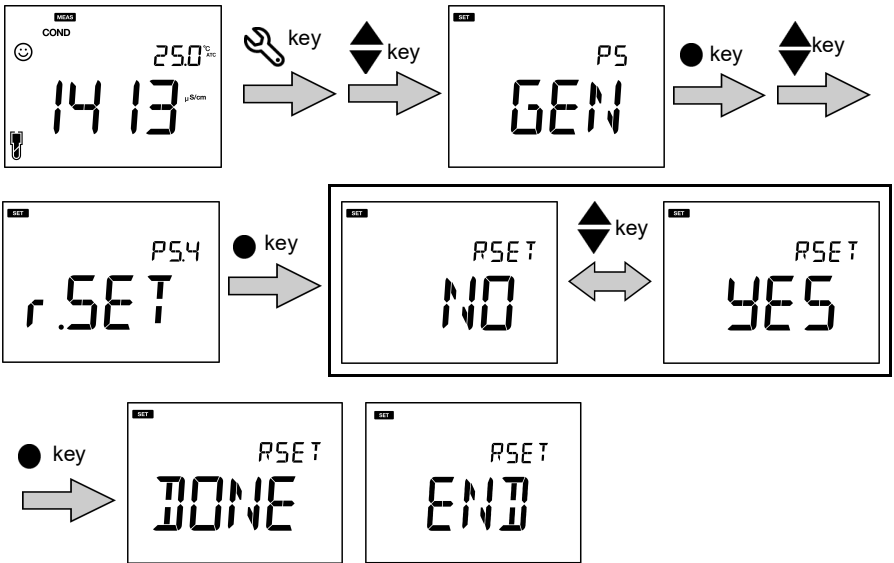

■ Maintenance and Storage

This section describes maintenance and storage of the instrument and the electrodes that are used with the instrument. To use them for a long period, perform the described maintenance procedures appropriately.

● Contact for Maintenance

Please contact your dealer for the product maintenance.

● Maintenance and Storage of the Instrument

- If the instrument is dirty, wipe it gently with a soft dry cloth. If it is difficult to remove the dirt, wipe it gently with a cloth moistened with alcohol.
- The instrument is made of solvent resistant materials but is not resistant to all chemicals. Do not dip the instrument in strong acid or alkali solution, or wipe it with such solutions.
- Do not wipe the instrument with polishing powder or other abrasive compound.

● Environmental Conditions for Storage

- Temperature: 0°C to 45°C
- Humidity: under 80% relative humidity and free from condensation

Avoid the following conditions:

- Dusty place
- Strong vibration
- Direct sunlight
- Corrosive gas environment
- Close to an air-conditioner
- Direct wind

● **Maintenance and Storage of Electrodes**

This section describes an overview of the procedures for maintenance and storage of pH, ORP and conductivity electrodes. For the detailed procedures, refer to the instruction manual for each electrode.

● **How to clean the electrodes**

When the tip of an electrode (responsive membrane and liquid junction) becomes dirty, the response time may slow or an error may occur in the measurement results. To avoid such errors, clean the electrode. For dirt that cannot be washed off by pure water (or deionized water), use the cleaning solution indicated below depending on the type of dirt. After cleaning, rinse the electrode with pure water (or deionized water).

However for pH and ORP electrodes, different cleaning solutions should be used to clean different types of dirt.

For pH Electrode

Type of dirt	Cleaning solution
General	Diluted neutral cleaning solution
Oil	Alcohol, or diluted neutral cleaning solution
Inorganic substance	1 mol/L HCl or electrode cleaning solution (model 220)
Protein	Cleaning solution including protein-removing enzyme (model 250)
Alkaline	Dip in 1 mol/L HCl or electrode cleaning solution (model 220) for 1h to 2 h

For ORP Electrode

Type of dirt	Cleaning solution
General	Dilute neutral cleaning solution (General dishwashing liquid works reasonably well.)
Oil	
Inorganic substance	Immerse dilute nitric acid (1:1 nitric acid)

For Conductivity Electrode

Always clean the cell in pure water (or deionized water) after every measurement. When the response is slow or residue from the sample adheres to the cell, use the appropriate method below to clean the cell, and then clean again with pure water (or deionized water).

Type of dirt	Cleaning solution
General	Diluted neutral cleaning solution
Inorganic substance	Ethanol (keep the ethanol away from plastic parts)
Scale that formed during long term storage	A commercially available scale remover (neutral cleansing solution for kitchen use, etc.) diluted by a factor of 100. If this does not remove the scale, use diluted solution that contains oxygen bleach (sodium percarbonate) or chlorine bleach (sodium hypochlorite).

• Daily storage of pH and ORP electrodes

If the electrode becomes dry, the response will be slow. Store in a moist atmosphere. Follow the steps below to properly store the electrode:

1. Wash the electrode well with pure water (or deionized water) to remove sample completely, and close the internal solution filler port.
2. Wash the inside of the protective cap with pure water (or deionized water), then add enough pure water (or deionized water) to soak the sponge.
3. Attach the protective cap.

• Daily storage of the conductivity electrode

If the electrode is stored in a dry state, the cell constant will change. Store with the black electrode part immersed in deionized water, or with the protective cap filled with deionized water and attached to the electrode.

To store the electrode for a long period, clean it well and attach the protective cap filled with deionized water.

Note

- When the electrode will not be used for a long period, store it by following the electrode storage procedure detailed above.
- For pH and ORP electrodes, replace the reference electrode internal solution with new solution once every 3 to 6 months.

■ Error Messages and Troubleshooting

● Error Messages

This section describes the causes of typical errors and the actions to be taken to resolve respective errors. Check these before contacting us.

If ERR is displayed while you are using the instrument, refer to the table below:

Error	Definition	Cause and Solution
OFFS ERR	Offset voltage error	Electrode is dirty or reference junction is clogged. Clean the electrode.
SLPE ERR	Slope error	Electrode sensitivity is low. Please clean and recalibrate with fresh standard solution. If the problem persists, replace the electrode with new one.
BUFF ERR	Cannot auto recognize pH buffer	The instrument cannot identify the pH buffer. Check the calibration solution and use fresh one if required.
STD ERR	Cannot auto recognize standard solution	The instrument cannot identify the standard solution. Check the calibration solution and use fresh one if required.
MEM FULL	Memory data full	The number of the data saved has exceeded the specified number of items. Print or transfer the data. Or, clear stored data.
	If user selects the enter key before stable in calibration mode	● key is pressed before the calibration value has stabilized. Wait for the value to be stable and then press the ● key.

● Troubleshooting

This section describes causes and actions to take for problems that customers frequently ask.

The indicated value fluctuates

< Problem with the electrode >

Cause	How to solve problem
The electrode is dirty.	Clean the electrode.
The electrode is cracked.	Replace the electrode.
The wrong internal solution is being used.	Use the correct internal solution.
There are air bubbles on the electrode.	Shake the electrode to remove the air bubbles.
The level of internal solution in reference electrode is low.	Replenish the internal solution of the reference electrode until it is higher than the level of the sample.

< Problem with the instrument >

Cause	How to solve problem
There is a motor or other device causing electrical interference.	Measure at a place where no influence from induction is given. Ground all AC-powered equipment.
The electrode is not connected correctly.	Connect the electrode properly.

< Problem with the sample >

Cause	How to solve problem
Electrode is not immersed enough to cover liquid junction.	The electrode must be immersed up to the liquid junction. As a guide, immerse to at least 3 cm from the tip of the electrode.
The stability of electrode is affected by the sample solution.	It is important to select an electrode that is appropriate for the sample. Consult your dealer. To confirm an electrode that is appropriate for the sample, check the pH electrode selection guide in our catalogue, or refer to our website.

Error Messages and Troubleshooting

The response is slow

Cause	How to solve problem
The electrode is dirty.	Clean the electrode.
The electrode is broken.	Replace the electrode.
The response of electrode is affected by the sample solution.	It is important to select an electrode that is appropriate for the sample. Consult your dealer. To confirm an electrode that is appropriate for the sample, check the pH electrode selection guide in our catalogue, or refer to our website.

The indicated value does not change

Cause	How to solve problem
The electrode is cracked.	Replace the electrode.
The electrode is not connected correctly.	Connect the electrode correctly.
The instrument is in HOLD state.	Cancel the HOLD state.
Instrument defect.	Consult your dealer.

The measured value is out of the measurement range

When the measured value is below the display range, "Ur" appears. When the measured value is over the display range, "Or" appears.

Cause	How to solve problem
Sample is out of the measurement range.	Use a sample within the measurement range.
Electrode is not immersed enough to cover liquid junction.	The electrode must be immersed up to the liquid junction. As a guide, immerse to at least 3 cm from the tip of the electrode.
The electrode cable is broken.	Replace the electrode.
Calibration is not performed or performed incorrectly.	Perform calibration correctly.
Instrument defect.	Check as explained below.

• How to check for instrument defect

Short the metal part of the outer tube to the center pin of the electrode connector of the corresponding channel of the instrument. If the measured value blinks or does not show zero, consult your dealer.

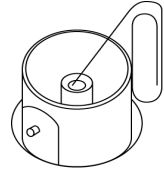

Repeatability of the measured value is poor

Cause	How to solve problem
Effect of the sample solution.	Repeatability becomes poor when the pH of the sample changes over time.
The electrode is dirty.	Clean the electrode.
The electrode is broken.	Replace the electrode.
The internal solution of the electrode runs out or contaminated.	Replace the internal solution with new one.
The level of internal solution in reference electrode is low.	Replenish the internal solution of the reference electrode until it is higher than the level of the sample.

Nothing appears when the power is turned ON

Cause	How to solve problem
Instrument defect.	Consult your dealer.
Power is not supplied.	Connect the AC adapter.

Swelling of keypad

Cause	How to solve problem
Using the instrument at high elevation or other location where the air pressure is different from sea level.	To eliminate the pressure difference between the inside and outside of the instrument, briefly open and then close the serial connector cover. After opening, correctly close the cover to maintain dust and water proofing.
Instrument defect.	Consult your dealer.

Part of the display is missing

Cause	How to solve problem
Instrument defect.	Check the display by switching ON the instrument when all the LCD segments are lit.

■ Appendix

This section describes the technical information, printer formats, and specifications of the instrument.

● Appendix 1

pH calibration can be performed according to several buffer standards. The most common standard is the US buffer standard. The default setup is US buffer standard. Alternative standards that can be chosen are NIST and DIN.

The pH buffers are temperature dependent i.e. the pH value changes with change in temperature. The meter is intelligent to detect the temperature and pH value associated with buffer when calibration is performed. It remembers all the temperature vs. pH value for all the standards.

The pH vs. temperature values for the various standards are listed below:

< USA >

Temp. (°C)	pH 1.68	pH 4.01	pH 7.00	pH 10.01	pH 12.46
0	1.67	4.01	7.12	10.32	13.42
5	1.67	4.01	7.09	10.25	13.21
10	1.67	4.00	7.06	10.18	13.00
15	1.67	4.00	7.04	10.12	12.81
20	1.68	4.00	7.02	10.06	12.63
25	1.68	4.01	7.00	10.01	12.45
30	1.69	4.01	6.99	9.97	12.29
35	1.69	4.02	6.98	9.93	12.13
40	1.70	4.03	6.97	9.89	11.98
45	1.70	4.04	6.97	9.86	11.84
50	1.71	4.06	6.97	9.83	11.70
55	1.72	4.08	6.97	9.81	11.57

< NIST >

Temp. (°C)	pH 1.68	pH 4.01	pH 6.86	pH 9.18	pH 12.46
0	1.67	4.01	6.98	9.46	13.42
5	1.67	4.01	6.95	9.39	13.21
10	1.67	4.00	6.92	9.33	13.00
15	1.67	4.00	6.90	9.27	12.81
20	1.68	4.00	6.88	9.22	12.63
25	1.68	4.01	6.86	9.18	12.45
30	1.69	4.01	6.85	9.14	12.29
35	1.69	4.02	6.84	9.10	12.13
40	1.70	4.03	6.84	9.07	11.98
45	1.70	4.04	6.83	9.04	11.84
50	1.71	4.06	6.83	9.01	11.70
55	1.72	4.08	6.83	8.99	11.57

< DIN >

Temp. (°C)	pH 1.09	pH 3.06	pH 4.65	pH 6.79	pH 9.23	pH 12.75
0	1.08	3.10	4.67	6.89	9.48	13.37
5	1.09	3.10	4.66	6.87	9.43	13.37
10	1.09	3.10	4.66	6.84	9.37	13.37
15	1.09	3.08	4.65	6.82	9.32	13.17
20	1.09	3.07	4.65	6.80	9.27	12.96
25	1.09	3.06	4.65	6.79	9.23	12.75
30	1.10	3.05	4.65	6.78	9.18	12.61
35	1.10	3.04	4.65	6.77	9.13	12.45
40	1.10	3.04	4.66	6.76	9.09	12.29
45	1.11	3.04	4.67	6.76	9.04	12.14
50	1.11	3.04	4.68	6.76	9.00	11.98
55	1.11	3.04	4.69	6.76	8.96	11.84

Note

Calibration is performed using Nernst's equation with the above values.

Conductivity Standard Values at Various Temperatures

Temp. (°C)	Conductivity value at 25°C			
	84 (µS/cm)	1413 (µS/cm)	12.88(S/cm)	111.8 (mS/cm)
15	68	1147	10.48	92.5
16	70	1173	10.72	94.4
17	71	1199	10.95	96.3
18	73	1225	11.19	98.2
19	74	1251	11.43	100.2
20	76	1278	11.67	102.1
21	78	1305	11.91	104.0
22	79	1332	12.15	105.9
23	81	1359	12.39	107.9
24	82	1386	12.64	109.8
25	84	1413	12.88	111.8
26	86	1440	13.13	113.8
27	87	1467	13.37	115.7
28	89	1494	13.62	117.7
29	90	1521	13.87	119.7
30	92	1548	14.12	121.8
31	94	1575	14.37	123.9

- Appendix 2

Printer Format- Measurement**pH**

Model	HORIBA PC1500
S/No	A91B1234
SW Rev	1.00
Mode	pH
pH	7.00 pH
mV	0.0 mV
Temp.	25.0 C (ATC)
Electrode	EXCELLENT
User Name	
Signature	

mV

Model	HORIBA PC1500
S/No	A91B1234
SW Rev	1.00
Mode	mV
mV	174.2 mV
Temp.	25.0 C (ATC)
User Name	
Signature	

Relative mV

Model	HORIBA PC1500
S/No	A91B1234
SW Rev	1.00
Mode	R.mV
R.mV	176.1 R.mV
Offset	-1.1 mV
Temp.	25.0 C (ATC)
User Name	
Signature	

Conductivity

Model	HORIBA PC1500
S/No	A91B1234
SW Rev	1.00
Mode	Conductivity
Cond	107.3 uS/cm
Temp.	23.2 C (ATC)
Electrode	EXCELLENT
User Name	
Signature	

Resistivity

Model	HORIBA PC1500
S/No	A91B1234
SW Rev	1.00
Mode	Resistivity
Resistivity	0.008 Mohm
Temp.	23.2 C (ATC)
User Name	
Signature	

Salinity

Model	HORIBA PC1500
S/No	A91B1234
SW Rev	1.00
Mode	Salinity
Salinity	0.1 ppt
Temp.	23.2 C (ATC)
Electrode	NO CAL
User Name	
Signature	

TDS

Model	HORIBA PC1500
S/No	A91B1234
SW Rev	1.00
Mode	TDS
TDS	52.1 mg/L
Temp.	23.3 C (ATC)
Electrode	EXCELLENT
User Name	
Signature	

Printer Format - Data Log

Model	HORIBA PC1500
S/No	A91B1234
SW Rev	1.00
User Name	
Signature	
Logged Data	
Location	6
Mode	pH
pH	4.59 pH
mV	142.9 mV
Temp.	25.0 C (ATC)
Electrode	EXCELLENT
Location	5
Mode	mV
mV	178.0 mV
Temp.	25.0 C (ATC)
Location	4
Mode	Conductivity
Cond	457.9 uS/cm
Temp.	22.5 C (ATC)
Electrode	EXCELLENT
Location	3
Mode	Salinity
Salinity	0.3 ppt
Temp.	22.7 C (ATC)
Electrode	NO CAL
Location	2
Mode	TDS
TDS	205 mg/L
Temp.	22.3 C (ATC)
Electrode	EXCELLENT
Location	1
Mode	Resistivity
Resistivity	0.002 Mohm
Temp.	22.3 C (ATC)

Printer Format - Calibration**pH**

Model	HORIBA PC1500
S/No	A91B1234
SW Rev	1.00
Calibration Data	
Cal Points	4.01
	7.00
	10.01
Offset	0.5 mV
Avg Slope	98.2%
Temp.	25.0 C (ATC)
Electrode	EXCELLENT
User Name	
Signature	

Conductivity

Model	HORIBA PC1500
S/No	A91B1234
SW Rev	1.00
Calibration Data	
Cal Points	84 uS/cm
	1413 uS/cm
	12.88 mS/cm
	111.8 mS/cm
Avg.CalFac	1.022
Temp.	23.2 C (ATC)
Electrode	EXCELLENT
User Name	
Signature	

Salinity

Model	HORIBA PC1500
S/No	A91B1234
SW Rev	1.00
Calibration Data	
Cal Point	0.2 ppt
Avg.CalFac	1.000
Temp.	22.3 C (ATC)
Electrode	EXCELLENT
User Name	
Signature	

• Meter Specifications

Specifications	LAQUA 1500
pH Range	-2.00 to 16.00 pH
Resolution	0.01 pH
Accuracy	± 0.01 pH
pH Buffer Groups	USA, NIST, DIN
Calibration Points	Up to 5 (USA, NIST) / Up to 6 (DIN)
ORP Range	± 2000.0 mV
Resolution	0.1 mV (< ±1000 mV), 1 mV (≥ ±1000mV)
Accuracy	±0.3 mV (< ±1000 mV), 0.3% of reading (≥ ±1000mV)
Calibration Option	Yes (Up to ±200 mV)
Conductivity Range	0.00 – 20.00 µS 20.1 – 200.0 µS 201– 2000 µS 2.01 – 20.00 mS 20.1 – 200.0 mS
Resolution	0.01 / 0.1 / 1 µS ; 0.01 / 0.1 mS
Accuracy	±0.6% full scale; ±1.5% full scale > 18.0 mS/cm
Reference Temperature	15.0 to 30.0 °C (adjustable)
Temperature Coefficient	0.00 to 10.00% per °C (adjustable)
Cell Constants	0.070 to 13.00 (adjustable)
Calibration Points	Up to 4 (Auto) / Up to 5 (Manual)
Units	S/cm, S/m (Auto ranging)
Resistivity Range	0.000 Ω•cm to 20.0 MΩ•cm
Resolution	0.5% full scale
Accuracy	±0.6% full scale, ±1.5% full scale > 1.80 MΩ•cm
Total Dissolved Solids (TDS) Range	0 – 10.00 ppm 10.1 – 100.0 ppm 101 – 1000 ppm 1.01 – 10.00 ppt 10.1 – 100 ppt
Resolution	0.01 / 0.1 / 1 ppm ; 0.01 / 0.1 ppt
Accuracy	±0.1% full scale
TDS Curves	EN27888, 442, NaCl, Linear (0.40 to 1.00)
Salinity Range	0.0 to 100.0 ppt / 0.00 to 10.00 %
Resolution	0.1 ppt / 0.01%
Accuracy	±0.2% full scale
Salinity Curves	NaCl / Seawater
Calibration Option	Yes
Temperature Range	-30.0 to 130.0 °C / -22.0 to 266.0 °F

Meter Specifications

Specifications	LAQUA 1500
Resolution	0.1 °C / °F
Accuracy	± 0.5 °C / ± 0.9 °F
Calibration Option	Yes (± 10.0 °C / ± 18.0 °F range in 0.1 °C increment)
Memory	1000 data sets
Auto Data Log	Yes
Measurement Modes	Auto Stable / Auto Hold / Real Time
Offset & Slope Display	Yes (Average slope)
Auto Shut-Off	Yes (programmable: 1 to 30 mins.)
Electrode Status	On screen display
PC / Printer Communication	Yes
Communication	Phono jack (USB / RS232)
Meter Inputs	BNC, phono (ATC), DC sockets
Display	Static segment LCD with 160 segments
Channel	2
Power Rating AC Adapter	Input Voltage: 100 - 240V, 50/60Hz
	Input Voltage: 7V
Power Rating Instrument	Power Consumption: 0.7 W / 100 mA
Dimensions	155 (L) x 150 (W) x 67 (H) mm
Weight	Approx 730g for PH1500 benchtop meter
	Approx 730g for EC1500 benchtop meter
	Approx 740g for PC1500 benchtop meter
Electrode Stand	Integrated
Warranty	3 years

• **Table of Conductivity Cell Range**

• Unit: S/m

Display Range	Cell Constant		
	0.1 cm ⁻¹	1 cm ⁻¹	10 cm ⁻¹
OR (Over Range)			100 S/m
2.00 ~ 20.00 S/m		10 S/m	~
0.200 ~ 1.999 S/m	1 S/m	~	1 mS/m
20.0 ~ 199.9 mS/m	~	0.1 mS/m	
2.00 ~ 19.99 mS/m			
0.000 ~ 1.999 mS/m	0.01 mS/m		

• Unit: S/cm

Display Range	Cell Constant		
	0.1 cm ⁻¹	1 cm ⁻¹	10 cm ⁻¹
OR (Over Range)			1000 mS/cm
20.0 ~ 200.0 mS/cm		100 mS/cm	~
2.00 ~ 19.99 mS/cm	10 mS/cm	~	10 μS/cm
200 ~ 1999 μS/cm	~	1 μS/cm	
20.0 ~ 199.9 μS/cm			
0.00 ~ 19.99 μS/cm	0.1 μS/cm		

• **Table of Conductivity Cell Range (Resistivity Range)**

• Unit: $\Omega \cdot \text{cm}$

Display Range	Cell Constant		
	0.1 cm^{-1}	1 cm^{-1}	10 cm^{-1}
OR (Over Range)	$10 \text{ M}\Omega \cdot \text{cm}$ ~ $100 \Omega \cdot \text{cm}$	$1 \text{ M}\Omega \cdot \text{cm}$ ~ $10 \Omega \cdot \text{cm}$	$100 \text{ k}\Omega \cdot \text{cm}$ ~ $1 \Omega \cdot \text{cm}$
$1.0 \sim 20.0 \text{ M}\Omega \cdot \text{cm}$			
$0.001 \sim 0.999 \text{ M}\Omega \cdot \text{cm}$			
$(0.0 \sim 999.9 \Omega \cdot \text{cm})$			

HORIBA Advanced Techno

2 Miyanohigashi-cho, Kisshoin, Minami-ku, Kyoto, 601-8551, Japan
<http://www.horiba-adt.jp>

For any questions regarding this product, please contact your local agency, or inquire from the following website.
http://global.horiba.com/contact_e/index.htm

Local: M004199
P/N: 3200910464
GZ: 0000644511